



INTRODUCTION

Welcome to issue 2 of our **Ancillary Products Catalogue**. Inside you will find a vast range of components catering for all your needs.

Products are grouped together under the following headings:- Switches & Warning Lights, Cable & Connectors, Towing & Touring, Relays & Flasher Units, Pumps & Solenoids, Horns & Gauges, Reversing Aids and Miscellaneous.

This catalogue illustrates a broad selection of our stock but by no means our full range. We consider our range to be the most in depth currently available from one single supplier in the U.K. aftermarket and compliments our 'Rotating Electrics' and 'Lighting' catalogues

There are a large number of items detailed within which are recent introductions to our rapidly expanding product portfolio and any part number that has been added is clearly identified.

The Ancillary range, as with all of our products has been developed with our five key objectives firmly in mind and which we consider to be central to the success of our joint trading relationships.

- We are committed to providing our customers with the highest levels of service.
- We are committed to marketing and selling only the highest quality products.
- We are committed to offering value for money.
- We are committed to providing added value service and support.
- We are committed to consistent and continual improvement of our range and services, which allows us to remain that little bit unique in our market place.

It is our intention wherever possible to continue to add further references to the **Five Star Products** Ancillary range and we will communicate these to you via our bi-monthly bulletins. I do hope you find that our programme fulfils all your requirements.

Kind Regards
H Bowers Limited



Jeff Savage
Managing Director



CONTACT NUMBERS

SALES ENQUIRIES/ORDERS



01782 590700

FAX

01782 590712

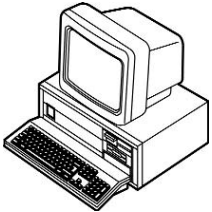

sales@bowersmidland.co.uk

TECHNICAL ENQUIRIES



01782 590702

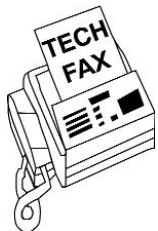

01782 598516

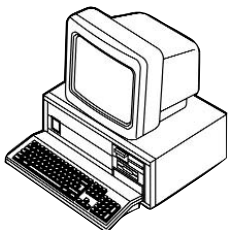

sales@bowersmidland.co.uk

CONTENTS

SWITCHES & WARNING LIGHTS	4-19
CABLE & CONNECTORS	20-49
TOWING & TOURING	50-67
RELAYS & FLASHER UNITS	68-72
PUMPS & SOLENOIDS	73-77
HORNS & GAUGES	78-87
REVERSING AIDS	88-94
MISCELLANEOUS	95-111
PART NUMBER INDEX	112-115
NOTES	116

SWITCHES & WARNING LIGHTS



SWITCHES

Battery isolator switch (12/24v).

[**9996000**](#)

Supplied with detachable key.
Complete with dust cover on switch.
Continuous loads:- **100 amps.**
Intermittent loads:- **500 amps.**



Spares	Description	Part No.
	Spare Key	9996000K

Battery isolator switch (12/24v).

[**9996030**](#)

Supplied with detachable key.
Complete with dust cover on switch.
Continuous loads:- **100 amps.**
Intermittent loads:- **500 amps.**
When turned to the 'off' position the engine will be automatically stopped due to the secondary switch function whereby the ignition circuit is cut. This prevents engine 'run on' and is a vital safety factor.

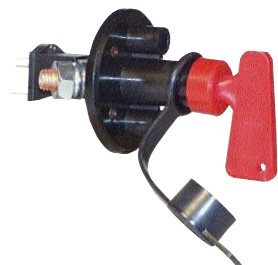

Spares	Description	Part No.
	Spare Key	9996030K



SWITCHES

Ignition switch.

Off/on/heater/ignition.
 Complete with 2 keys.
 Suitable for agricultural
 and plant applications.
 Equivalent to **9996057**
 (see **above**).

[35670](#)

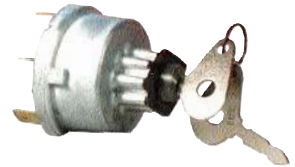

Spares	Description	Part No.
	Spare Key	9996057K



Barrel & keys.

Complete with 2 keys.
 Size - 30mm.
 Fits Lucas type
 ignition switches.

[9996013](#)



Push button switch (12/24v).

Momentary switch.
 Push for on, none latching.
 Waterproof.
 Suitable for agricultural and plant applications.
12v applications rated at **30 amps** intermittent.
24v applications rated at **15 amps** intermittent.
 Fixing:- 15mm dia. hole size.
 Screw terminals.

[9996002](#)



Push button switch (12v).

Momentary switch.
 Push for on, none latching.
 Heavy duty.
 Rated at **16 amps**.
 Fixing:- 25mm dia. hole size.
 Screw terminals.

[9996033](#)



Spares	Description	Part No.
	Waterproof cover	9996034

SWITCHES

9996039

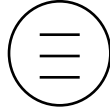

Illuminated push button switch (12v).

Push on/push off, latching.
Red L.E.D on button.
Rated at **16 amps**.
Square switch, round hole fixing.
Fixing:- 11mm dia. hole size.
Lucar terminals.



Illuminated push/pull switch (12v).

On/off, latching.
Complete with bulb.
Rated at **16 amps**.
Fixing:- 11mm dia. hole size.
Lucar terminals.

Description	Part No.
Amber	9996035
Blue	9996038

Description	Part No.
Green	9996036
Red	9996037

9996040

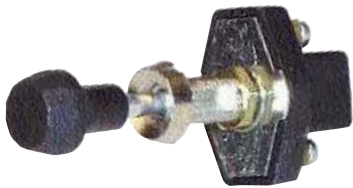

Push/pull switch (12/24v).

On/off, latching.
Rated at **16 amps**.
Fixing:- 7mm dia. hole size.
Screw terminals.

9996041



Illuminated rocker switch (12v).

On/off, latching.
Complete with bulb.
Supplied with symbols and coloured lenses (red, yellow, blue & green).
4 pin for use with relay.
Rated at **20 amps**.
Fixing:- 20mm (H) x 34mm (W) aperture required.
Lucar terminals.



SWITCHES

Illuminated rocker switch (12v).

[9996042](#)

On/off, latching.
 Complete with bulb.
 Supplied with symbols and coloured lenses (red, yellow, blue & green).
 Rated at **20 amps**.
 Fixing:- 20mm (H) x 34mm (W) aperture required.
 Lucar terminals.



Illuminated rocker switch (12v).

On/off, latching.
 Available with various coloured L.E.D's.
 Rated at **16 amps**.
 Oval switch, round hole fixing.
 Fixing:- 11mm dia. hole size.
 Lucar terminals.

Description	Part No.
Amber	9996043
Green	9996044
Red	9996045

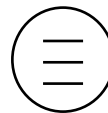

Illuminated mini rocker switch (12v).

On/off, latching.
 Available with various coloured L.E.D's.
 Rated at **16 amps**.
 Fixing:- 20mm dia hole size.
 Lucar terminals.

Description	Part No.
Amber	9996047
Red	9996046

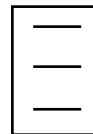

Mini rocker switch.

[9996048](#)

On/off, latching.
 Rated at **10 amps**.
 Fixing:- 20mm dia hole size.
 Lucar terminals.

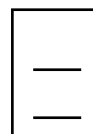

SWITCHES

9996049

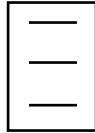

Mini rocker switch.

On/off, latching.
Rated at **16 amps**.
Fixing:- 19mm (H) x 12mm (W)
aperture required.
Lucar terminals.

9996015

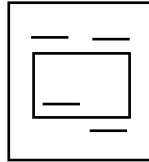

Rocker switch with circuit breaker.

On/off, latching.
8 amp circuit breaker incorporated.
Fixing:- 45mm (H) x 22mm (W)
aperture required.
Lucar terminals.

Illuminated rocker switch (24v).

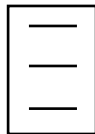
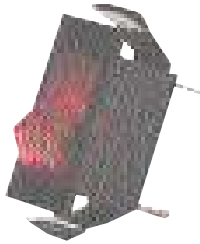

On/off, latching.
Illuminated switch
(available in amber or red).
Rated at **16 amps**.
Fixing:- 27mm (H) x 12mm (W)
aperture required.
Lucar terminals.

Description	Part No.
Amber	9996017
Red	9996018

9996022

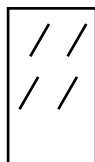

Rocker switch.

On/off, latching.
Rated at **16 amps**.
Fixing:- 37mm (H) x 21mm (W)
aperture required.
Lucar terminals.

SWITCHES

Toggle switch.

On/off/change over, latching.
Rated at **10 amps**.
Brass lever.
Nickel plated finish.
Fixing:- 11mm dia. hole size.
Lucar terminals.

[9996025](#)

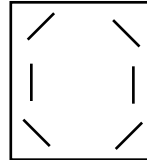

Toggle switch.

On/off, latching.
Heavy duty.
Rated at **25 amps**.
Metal lever.
Fixing:- 11mm dia. hole size.
Screw terminals.

[9996052](#)

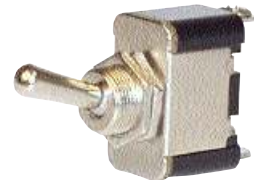
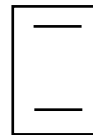

Toggle switch.

Spring loaded flash/off,
none latching.
Heavy duty.
Metal lever.
Rated at **25 amps**.
Fixing:- 11mm dia. hole size.
Screw terminals.

[9996055](#)

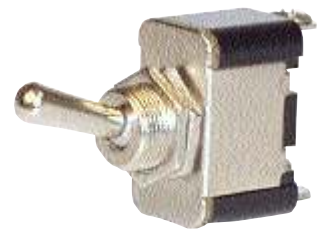
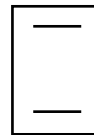

Toggle switch.

On/on, latching.
Heavy duty.
Metal lever.
Rated at **25 amps**.
Fixing:- 11mm dia. hole size.
Screw terminals.

[9996053](#)



SWITCHES

9996051



Toggle switch.

On/off/on, latching.
Heavy duty.
Metal lever.
Rated at **25 amps**.
Fixing:- 11mm dia. hole size.
Screw terminals.

9996050

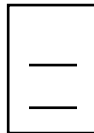

Toggle switch.

On/off, latching.
Heavy duty.
Metal lever.
Rated at **25 amps**.
Fixing:- 11mm dia. hole size.
Lucar terminals.

9996054

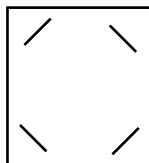

Toggle switch.

On/off, latching.
Twin circuit.
Metal lever.
Rated at **20 amps**.
Fixing:- 11mm dia. hole size.
Screw terminals.



SWITCHES

Micro switch.

[9996027](#)

Zinc alloy housing.
 Mild steel zinc plated plunger.
 Actuating force maximum n (0zf):- 11 (40) .
 Release force maximum n (0zf):- 1.1 (4).
 Screw terminals.
 Rated to IP54*.



Recommended Max. Electrical Ratings		
Voltage	Resistive Load	Inductive Load
AC	Amps	Amps
Up To 250	15	15

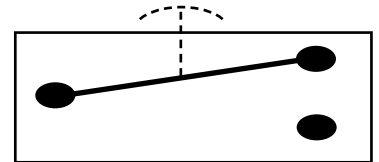

Recommended Max. Electrical Ratings		
Voltage	Resistive Load	Inductive Load
DC	Amps	Amps
Up To 30	15	15
Up To 50	5	5
Up To 75	2.5	2

*See IP ratings guide (page 192).

Micro switch.

[9996026](#)

Zinc alloy housing.
 Stainless steel plunger.
 Actuating force maximum n (0zf):- 7.2 (26) .
 Release force maximum n (0zf):- 1.7 (6).
 Screw terminals.
 Rated to IP67*.



Recommended Max. Electrical Ratings		
Voltage	Resistive Load	Inductive Load
AC	Amps	Amps
Up To 250	15	5

Recommended Max. Electrical Ratings		
Voltage	Resistive Load	Inductive Load
DC	Amps	Amps
Up To 15	15	8
Up To 30	2	1
Up To 50	0.7	0.5
Up To 75	0.5	0.2

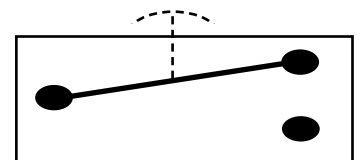

*See IP ratings guide (page 192).

SWITCHES

201.100

Multi-function switch.

Non self-cancelling directional indicator, main beam, dip beam, headlamp flash & horn.

To suit ø45mm steering column.

Cable length:- 200mm.



A = 230mm
B = 64.5mm
C = 57mm
D = 47mm

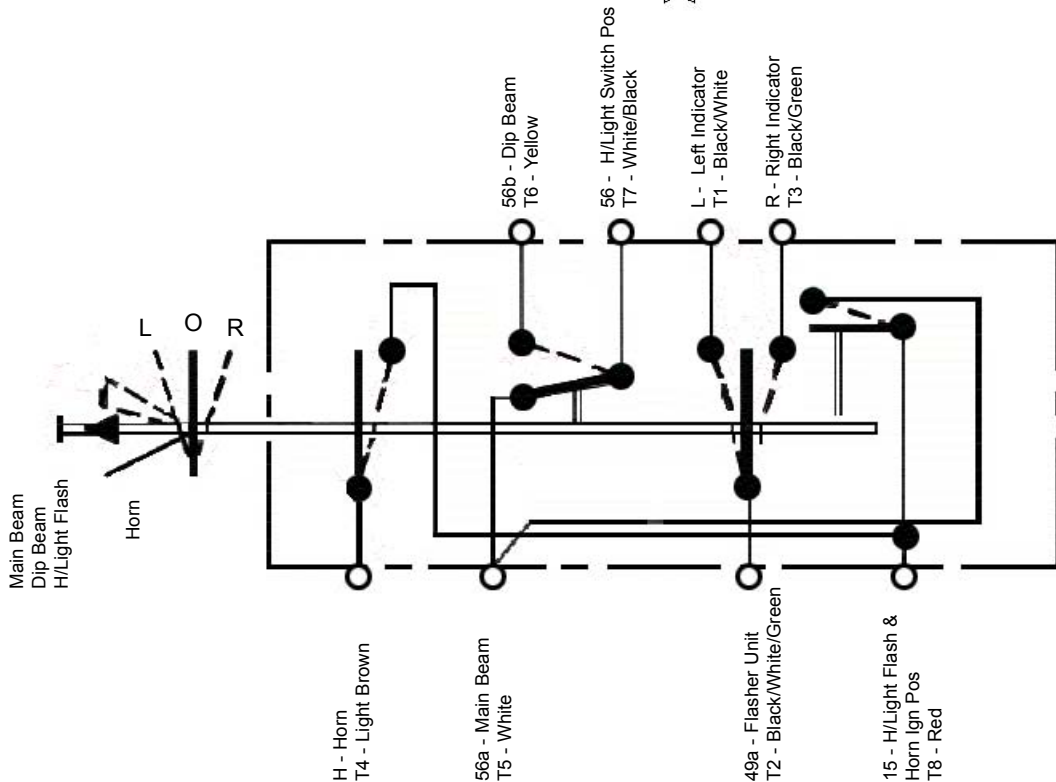
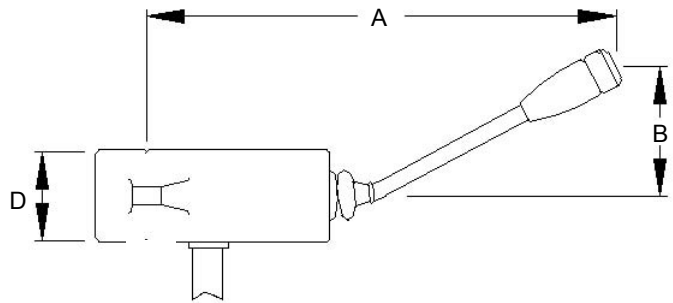
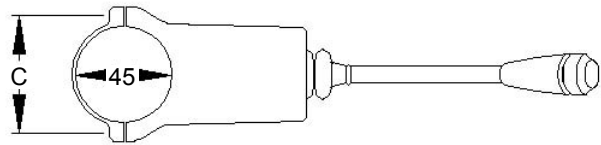



SWITCHES

Multi-function switch.

201.308

Self-cancelling directional indicator, lane change, main beam/dip beam, headlamp flash, horn, wash, 2 speed wipe & intermittent wipe.

Left hand only.

To suit ø45mm steering column.

Cable length:- 480mm.

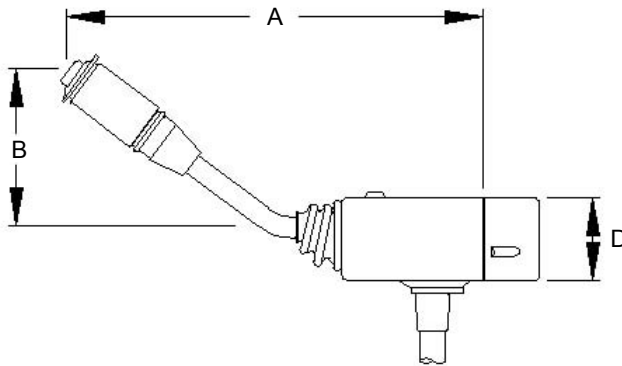
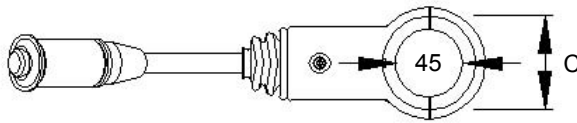

- A = 275mm
- B = 104mm
- C = 65mm
- D = 55mm

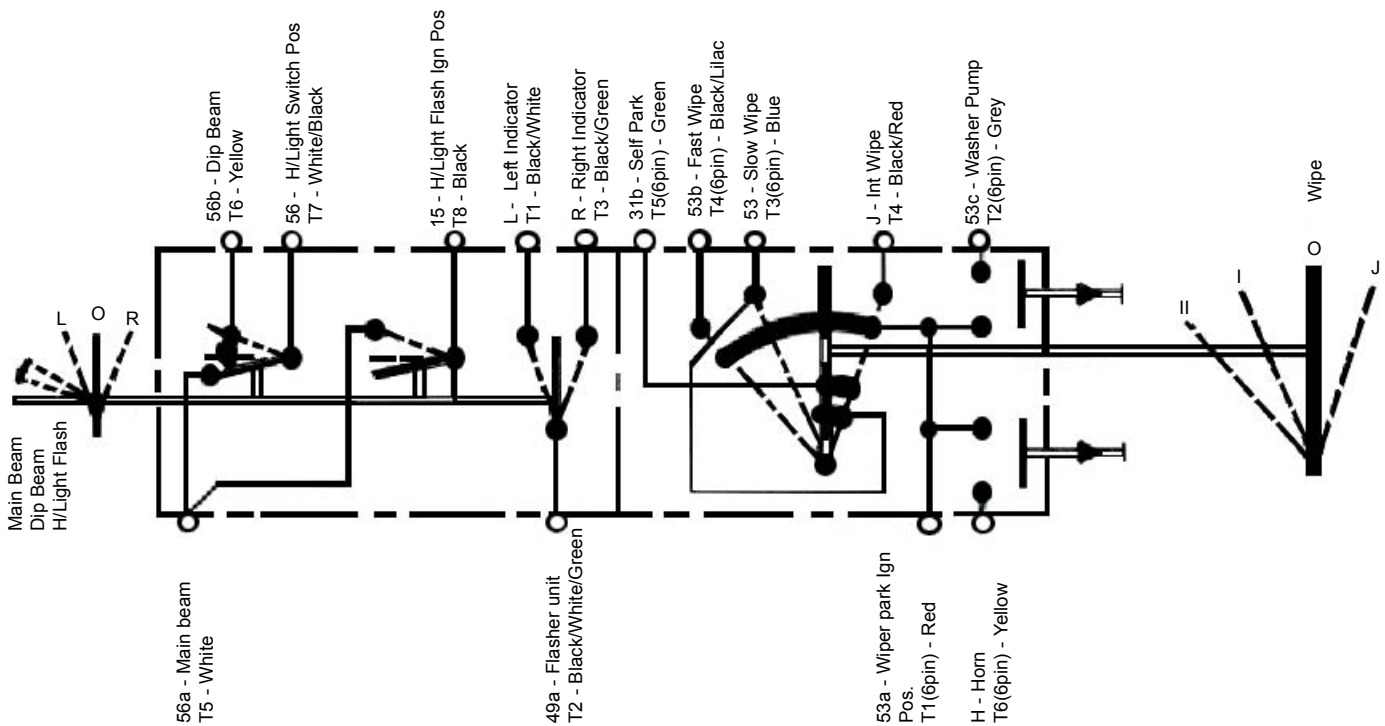

SWITCHES

201.545

Multi-function switch.

Self-cancelling directional indicator, lane change, main beam/dip beam, headlamp flash, horn, wash, 2 speed wipe & intermittent wipe.

Left hand only.

To suit ø45mm steering column.

Cable length:- 230mm.



- A = 250mm
- B = 75mm
- C = 62mm
- D = 55mm

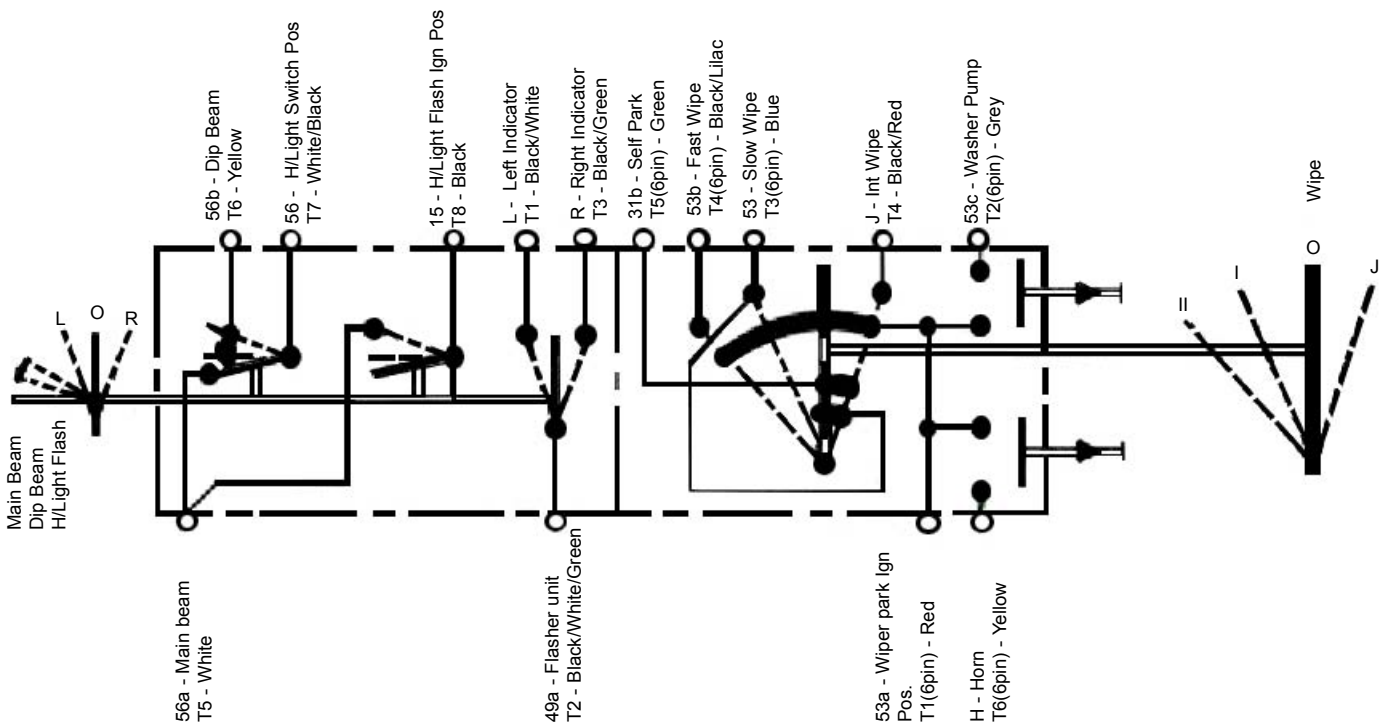
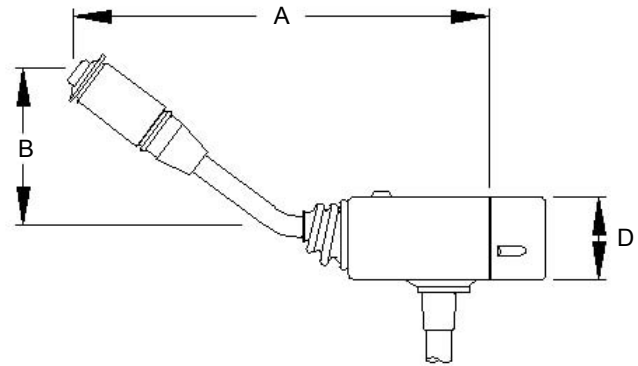
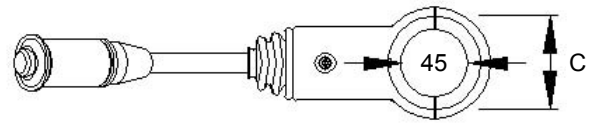



SWITCHES

Multi-function switch.

201.413

Self-cancelling directional indicator, lane change, main beam/dip beam, headlamp flash, horn, wash, 2 speed wipe & intermittent wipe.

Left hand only.

To suit ø45mm steering column.

Cable length:- 320mm.

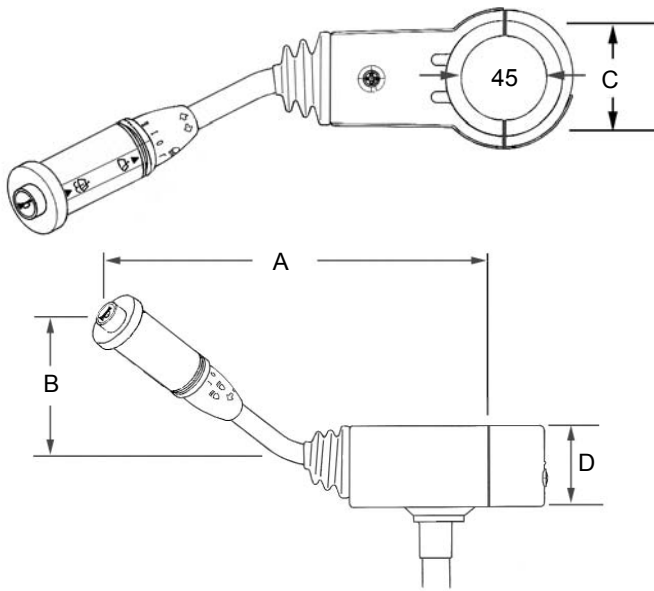

- A = 256mm
- B = 93mm
- C = 62mm
- D = 55mm

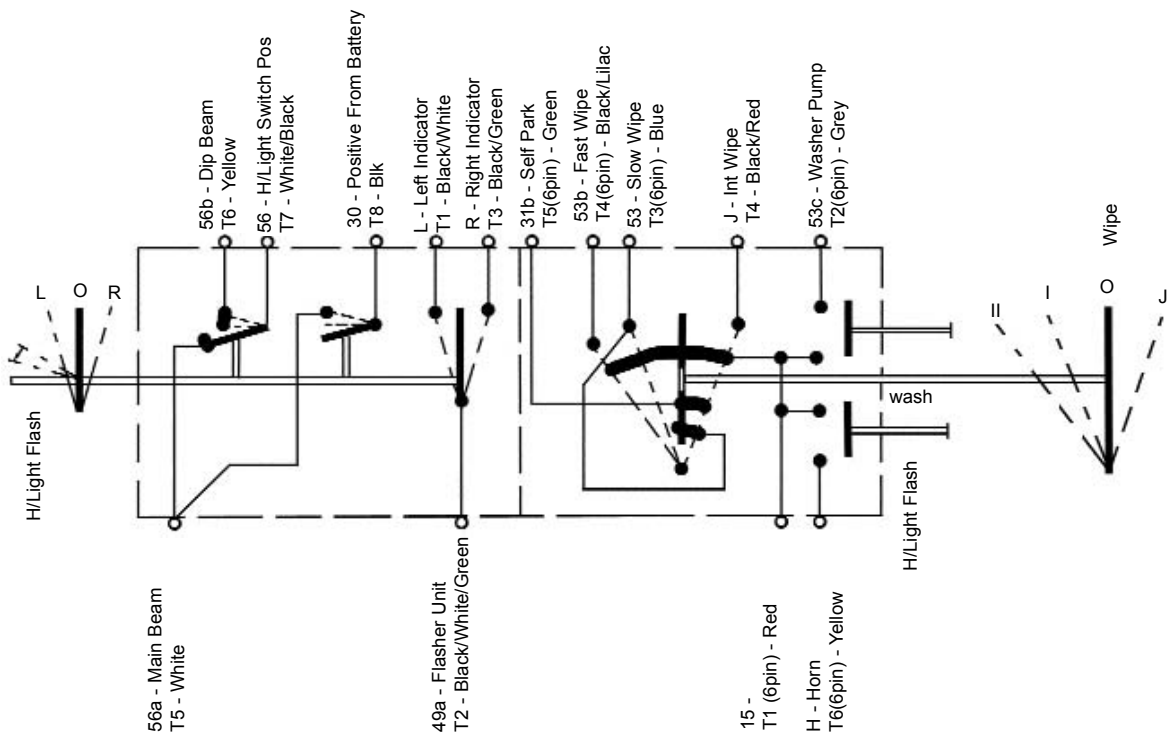

SWITCHES

201.772



Multi-function switch.

Forward, neutral & reverse.
 Left hand only.
 To suit ø45mm steering column.
 This switch is not fitted with a clamp assembly.

A = 252mm
 B = 55mm
 C = 62mm

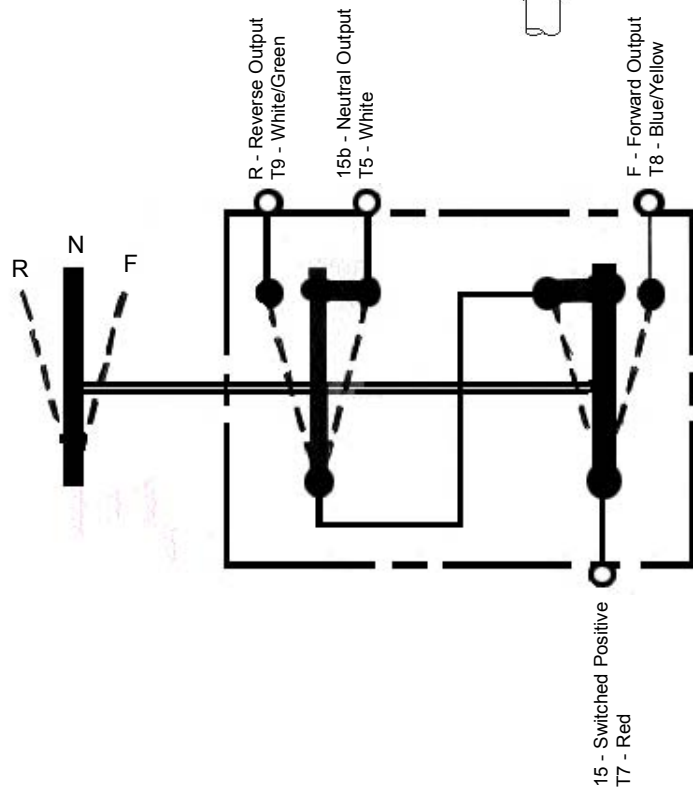
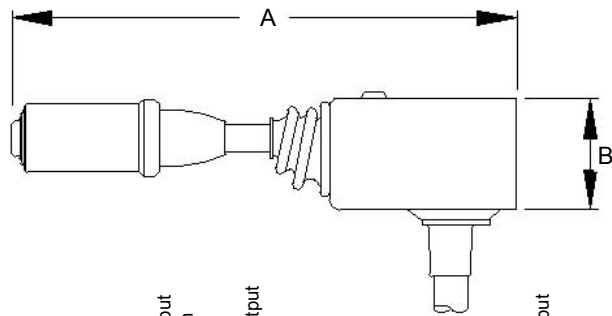
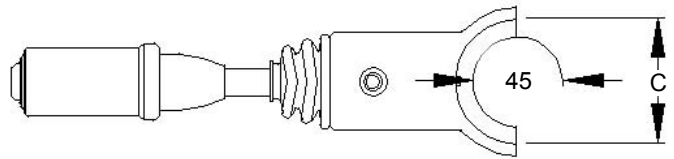



WARNING LIGHTS

Warning light (12v).

Available in various colours.
 Chrome bezel.
 Complete with 12v 0.7watt
 non-replaceable bulb.
 Lucar terminals.
 Fixing:- 13mm dia. hole size.



Description	Part No.
Amber	9996500
Blue	9996501

Description	Part No.
Green	9996502
Red	9996503

Warning light (12v).

Available in various colours.
 Complete with 12v 3watt
 replaceable bulb.
 Screw terminals.
 Fixing:- 16mm dia. hole size.



Description	Part No.
Amber	9996504
Blue	9996505

Description	Part No.
Green	9996506
Red	9996507

Warning light (12v).

Red L.E.D.
 Complete with flying lead.
 Choice of flashing or
 static operation.
 Fixing:- 8mm dia. hole size.



Description	Part No.
Flashing	9996508
Static	9996509

Warning light (12v).

Red L.E.D.
 Chrome housing.
 Lucar terminals.
 Fixing:- 7mm dia. hole size.

[9996510](#)



CABLE & CONNECTORS

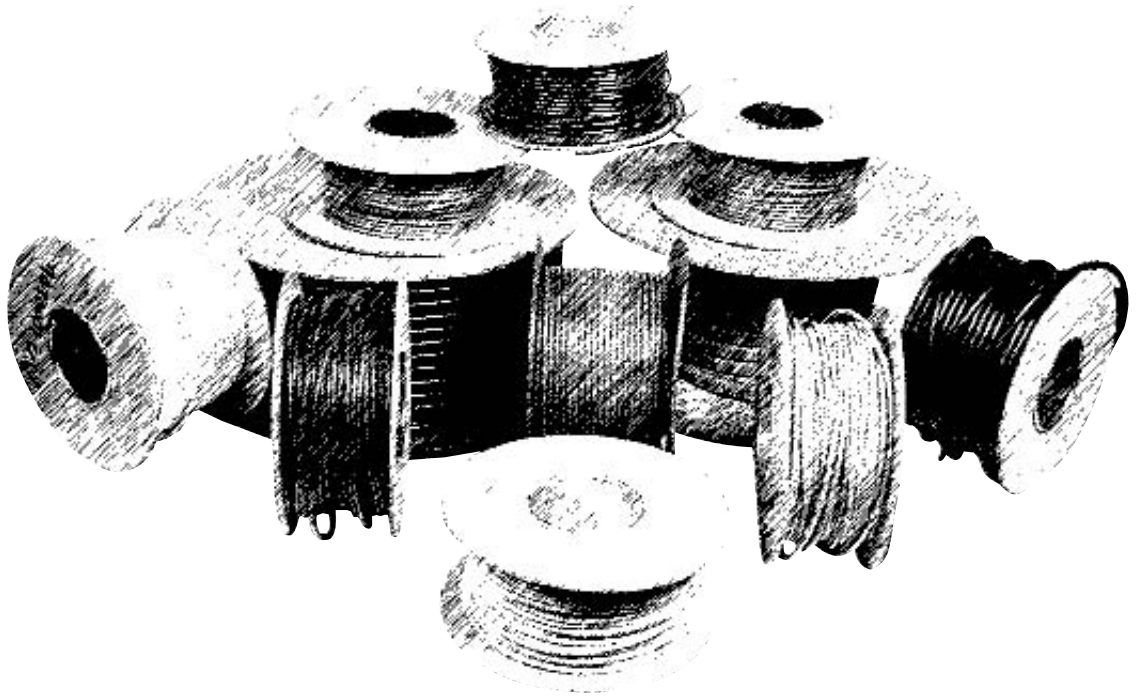



CABLE & CONNECTORS

STANDARD SINGLE CORE CABLE

NOTE: For colour required use part number plus colour code. E.G. 14/0.30mm 1.0mm² in black is part number 907000BB

14/0.30mm 1.0mm ² 50m rolls. Part No: 9070000		14/0.30mm 1.0mm ² 50m rolls. Part No: 9070000		28/0.30mm 2.0mm ² 50m rolls. Part No: 9070001		44/0.30mm 3.0mm ² 50m rolls.. Part No: 9070003	
Colour	Code	Colour	Code	Colour	Code	Colour	Code
Black	BB	Purple/White	PW	Brown	NN	Black	BB
Black/Blue	BU	Purple/Yellow	PY	Brown/Black	NB	Blue	UU
Black/Green	BG	Red	RR	Brown/Blue	NU	Brown	NN
Black/Orange	BT	Red/Black	RB	Brown/Green	NG	Green	GG
Black/Red	BR	Red/Blue	RU	Brown/Purple	NP	Purple	PP
Black/Slate	BS	Red/Brown	RN	Brown/White	NW	Red	RR
Black/White	BW	Red/Green	RG	Green	GG	White	WW
Black/Yellow	BY	Red/Orange	RO	Green/Purple	GP	Yellow	YY
Blue	UU	Red/Purple	RP	Green/White	GW	65/0.30mm 4.5mm²	
Blue/Black	UB	Red/Slate	RS	Green/Yellow	GY	30m rolls. Part No: 9070004	
Blue/Brown	UN	Red/White	RW	Orange	TT	Black	BB
Blue/Green	UG	Red/Yellow	RY	Orange/Green	TG	Brown	NN
Blue/Red	UR	Slate	SS	Pink	KK	Brown/White	NW
Blue/Slate	US	Slate/Yellow	SY	Purple	PP	Red	RR
Blue/White	UW	Slate/Black	SB	Purple/Black	PB	White/Red	WR
Blue/Yellow	UY	Slate/Light Green	SL	Purple/Yellow	PY	Yellow	YY
Brown	NN	White	WW	Red	RR	97/0.30mm 7.0mm²	
Brown/Black	NB	White/Black	WB	Red/Black	RB	30m rolls. Part No: 9070005	
Brown/Blue	NU	White/Blue	WU	Red/Blue	RU	Black	BB
Brown/Green	NG	White/Brown	WN	Red/Green	RG	Brown	NN
Brown/Red	NR	White/Green	WG	Red/White	RW	Brown/White	NW
Brown/White	NW	White/Orange	WT	Red/Yellow	RY	120/0.30mm 8.5mm²	
Brown/Yellow	NY	White/Purple	WP	Slate	SS	30m rolls. Part No: 9070006	
Green	GG	Yellow	YY	White	WW	Black	BB
Green/Blue	GT	Yellow/Black	YB	White/Green	WG	Brown	NN
Green/Brown	GN	Yellow/Blue	RU	White/Purple	WP	Red	RR
Green/Pink	GK	Yellow/Green	YG	Yellow	YY		
Green/Purple	GP	Yellow/Purple	YP	Yellow/Black	YB		
Green/Red	GR	Yellow/Red	YR	Yellow/Green	YG		
Green/White	GU	Yellow/Slate	RS	Yellow/Red	YR		
Green/Yellow	GY	Yellow/White	YW	Yellow/White	YW		
Light Green	LL	28/0.30mm 2.0mm²		35/0.30mm 2.5mm²			
Light Green/Black	LB	50m rolls. Part No: 9070001		50m rolls. Part No: 9070002			
Light Green/Brown	LN	Black	BB	Black	BB		
Light Green/Red	LR	Black/Green	BG	Blue	UU		
Light Green/Slate	LS	Black/Red	BR	Brown	NN		
Light Green/Yellow	LY	Black/Yellow	BY	Green	GG		
Orange	TT	Blue	UU	Red	RR		
Orange/White	TW	Blue/Brown	UN	White	WW		
Pink	KK	Blue/Green	UG	Yellow	YY		
Purple	PP	Blue/Orange	UT				
Purple/Black	PB	Blue/Red	UR				
Purple/Blue	PU	Blue/Slate	US				
Purple/Green	PG	Blue/White	UW				
Purple/Pink	PK	Blue/Yellow	UY				
Purple/Red	PR						
Purple/Slate	PS						

CABLE & CONNECTORS

Multicore cable

PARTNO	SIZE	SHEATH	CORE COLOURS	LENGTH
9070007	2x14/0.30mm 1.0mm ²	White PVC Flat	Black, Red	30 Mtrs
9070008	2x14/0.30mm 1.0mm ²	Black PVC Flat	Black, Red	30 Mtrs
9070009	2x14/0.30mm 1.0mm ²	Black PVC Flat	Black, Red	100 Mtrs
9070010	2x14/0.30mm 1.0mm ²	Black PVC Flat	Black, White	100 Mtrs
9070011	2x14/0.30mm 1.0mm ²	Black PVC Flat	Blue, White	100 Mtrs
9070012	2x14/0.30mm 1.0mm ²	Black PVC Flat	Brown, White	100 Mtrs
9070013	2x14/0.30mm 1.0mm ²	Black PVC Flat	Blue, Brown	100 Mtrs
9070014	2x28/0.30mm 2.0mm ²	Black PVC Flat	Black, Red	30 Mtrs
9070015	2x28/0.30mm 2.0mm ²	Black PVC Flat	Black, Red	100 Mtrs
9070016	2x44/0.30mm 3.0mm ²	Black PVC Flat	Black, Red	30 Mtrs
9070017	2x65/0.30mm 4.5mm ²	Black PVC Flat	Black, Red	30 Mtrs
9070018	3x24/0.20mm 0.75mm ² 6 Amp	Black Rubber Round	Blue, Brown, Green/Yellow	30 Mtrs
9070019	3x30/0.25mm 1.5mm ² 15 Amp	Black Rubber Round	Blue, Brown, Green/Yellow	30 Mtrs
9070020	2x24/0.25mm 1.5mm ² 6 Amp	Black PVC Round	Blue, Brown	30 Mtrs
9070021	3x25/0.20mm 0.75mm ² 6 Amp	Black PVC Round	Blue, Brown, Green/Yellow	30 Mtrs
9070022	3x30/0.25mm 1.5mm ² 15 Amp	Black PVC Round	Blue, Brown, Green/Yellow	30 Mtrs
9070023	2x13/0.20mm 0.75mm ²	Black PVC Flat	Black, Black/White	30 Mtrs
9070024	2x13/0.20mm 0.75mm ²	Black PVC Flat	Black, Black/White	100 Mtrs
9070025	3x14/0.30mm 1.0mm ²	Black PVC Round	Red, Black, Green	30 Mtrs
9070026	4x14/0.30mm 1.0mm ²	Black PVC Round	Brown, Green, Red, White	30 Mtrs
9070027	4x14/0.30mm 1.0mm ²	Black PVC Round	Brown, Green, Red, White	100 Mtrs
9070028	5x14/0.30mm 1.0mm ²	Black PVC Round	Brown, Green, Red, White, Yellow	30 Mtrs
9070029	6x14/0.30mm 1.0mm ² 1x28/0.30mm 2.0mm ²	Black PVC Round	Brown, Black, Blue, Green, Red, White, Yellow	30 Mtrs
9070030	6x14/0.30mm 1.0mm ² 1x28/0.30mm 2.0mm ²	Black PVC Round	Brown, Black, Blue, Green, Red, White, Yellow	100 Mtrs
9070031	6x21/0.30mm 1.5mm ² 1x35/0.30mm 2.5mm ²	Grey PVC Round	Brown, Black, Blue, Green, Red, White, Yellow	30 Mtrs



CABLE & CONNECTORS

Battery/Starter Cable

PARTNO	SIZE	AMPS	CORE COLOUR	LENGTH
9070035	37/0.90mm 25mm ²	170	Black	10 Mtrs
9070036	37/0.90mm 25mm ²	170	Black	30 Mtrs
9070037	37/0.90mm 25mm ²	170	Red	10 Mtrs
9070038	37/0.90mm 25mm ²	170	Red	30 Mtrs
9070039	61/0.90mm 40mm ²	300	Black	10 Mtrs
9070040	61/0.90mm 40mm ²	300	Black	30 Mtrs
9070041	61/0.90mm 40mm ²	300	Red	10 Mtrs
9070042	61/0.90mm 40mm ²	300	Red	30 Mtrs
9070043	61/1.13mm 60mm ²	415	Black	10 Mtrs
9070044	61/1.13mm 60mm ²	415	Black	30 Mtrs
9070045	61/1.13mm 60mm ²	415	Red	10 Mtrs
9070046	61/1.13mm 60mm ²	415	Red	30 Mtrs
9070047	1107/0.20mm 70mm ²	290	Black	10 Mtrs
9070048	2214/0.20mm 70mm ²	485	Red	10 Mtrs
9070052	2214/0.20mm 70mm ²	485	Red	10 Mtrs
9070049	2214/0.20mm 40mm ²	300	Black	50 Mtrs
9070050	2214/0.20mm 40mm ²	300	Red	50 Mtrs
9070054	1107/0.20mm 70mm ²	290	Red	10 Mtrs

Ignition Cable

PARTNO	SIZE	Conductor	CORE COLOUR	SHEATH	LENGTH
9070051	7mm ²	Copper	Black	PVC	30 Mtrs
9070052	7mm ²	Resistive	Black	PVC	30 Mtrs
9070053	7mm ²	Resistive	Black	TPE	30 Mtrs

Thin Wall Cable

NOTE: For colour required use part number plus colour code.
E.G. 16/020mm 0.5mm² in black is part number 9070060BB

16/0.20mm 0.5mm² Part number: 9070060 <table border="1"> <thead> <tr><th>Colour</th><th>Code</th></tr> </thead> <tbody> <tr><td>Black</td><td>BB</td></tr> <tr><td>Green/Black</td><td>GB</td></tr> <tr><td>Green</td><td>GG</td></tr> <tr><td>Green/Yellow</td><td>GY</td></tr> <tr><td>Brown</td><td>NN</td></tr> <tr><td>Red</td><td>RR</td></tr> <tr><td>Blue</td><td>UU</td></tr> <tr><td>White</td><td>WW</td></tr> <tr><td>Yellow</td><td>YY</td></tr> </tbody> </table>	Colour	Code	Black	BB	Green/Black	GB	Green	GG	Green/Yellow	GY	Brown	NN	Red	RR	Blue	UU	White	WW	Yellow	YY	24/0.20mm 0.75mm² Part number: 9070061 <table border="1"> <thead> <tr><th>Colour</th><th>Code</th></tr> </thead> <tbody> <tr><td>White</td><td>WW</td></tr> <tr><td>Yellow</td><td>YY</td></tr> </tbody> </table>	Colour	Code	White	WW	Yellow	YY	30/0.25mm 1.5mm² Part number: 9070063 <table border="1"> <thead> <tr><th>Colour</th><th>Code</th></tr> </thead> <tbody> <tr><td>Black</td><td>BB</td></tr> <tr><td>Purple</td><td>PP</td></tr> <tr><td>Red</td><td>RR</td></tr> <tr><td>White</td><td>WW</td></tr> <tr><td>Yellow</td><td>YY</td></tr> </tbody> </table>	Colour	Code	Black	BB	Purple	PP	Red	RR	White	WW	Yellow	YY	44/0.30mm 3.0mm² Part number: 9070066 <table border="1"> <thead> <tr><th>Colour</th><th>Code</th></tr> </thead> <tbody> <tr><td>Black</td><td>BB</td></tr> <tr><td>Red</td><td>RR</td></tr> </tbody> </table>	Colour	Code	Black	BB	Red	RR																						
Colour	Code																																																																				
Black	BB																																																																				
Green/Black	GB																																																																				
Green	GG																																																																				
Green/Yellow	GY																																																																				
Brown	NN																																																																				
Red	RR																																																																				
Blue	UU																																																																				
White	WW																																																																				
Yellow	YY																																																																				
Colour	Code																																																																				
White	WW																																																																				
Yellow	YY																																																																				
Colour	Code																																																																				
Black	BB																																																																				
Purple	PP																																																																				
Red	RR																																																																				
White	WW																																																																				
Yellow	YY																																																																				
Colour	Code																																																																				
Black	BB																																																																				
Red	RR																																																																				
24/0.20mm 0.75mm² Part number: 9070061 <table border="1"> <thead> <tr><th>Colour</th><th>Code</th></tr> </thead> <tbody> <tr><td>Black</td><td>BB</td></tr> <tr><td>Green</td><td>GG</td></tr> <tr><td>Brown</td><td>NN</td></tr> <tr><td>Purple</td><td>PP</td></tr> <tr><td>Red</td><td>RR</td></tr> <tr><td>Orange</td><td>TT</td></tr> <tr><td>Yellow</td><td>YY</td></tr> </tbody> </table>	Colour	Code	Black	BB	Green	GG	Brown	NN	Purple	PP	Red	RR	Orange	TT	Yellow	YY	32/0.20mm 1.0mm² Part number: 9070062 <table border="1"> <thead> <tr><th>Colour</th><th>Code</th></tr> </thead> <tbody> <tr><td>Black</td><td>BB</td></tr> <tr><td>Green</td><td>GG</td></tr> <tr><td>Pink</td><td>KK</td></tr> <tr><td>Brown/Black</td><td>NB</td></tr> <tr><td>Brown</td><td>NN</td></tr> <tr><td>Pink</td><td>PP</td></tr> <tr><td>Red/Black</td><td>RB</td></tr> <tr><td>Red</td><td>RR</td></tr> <tr><td>Red/Orange</td><td>RT</td></tr> <tr><td>Slate</td><td>SS</td></tr> <tr><td>Orange</td><td>TT</td></tr> <tr><td>Blue</td><td>UU</td></tr> <tr><td>White</td><td>WW</td></tr> <tr><td>Yellow</td><td>YY</td></tr> </tbody> </table>	Colour	Code	Black	BB	Green	GG	Pink	KK	Brown/Black	NB	Brown	NN	Pink	PP	Red/Black	RB	Red	RR	Red/Orange	RT	Slate	SS	Orange	TT	Blue	UU	White	WW	Yellow	YY	28/0.30mm 2.0mm² Part number: 9070064 <table border="1"> <thead> <tr><th>Colour</th><th>Code</th></tr> </thead> <tbody> <tr><td>Black</td><td>BB</td></tr> <tr><td>Green</td><td>GG</td></tr> <tr><td>Red</td><td>RR</td></tr> <tr><td>Blue</td><td>UU</td></tr> <tr><td>Yellow</td><td>YY</td></tr> </tbody> </table>	Colour	Code	Black	BB	Green	GG	Red	RR	Blue	UU	Yellow	YY	65/0.30mm 4.5mm² Part number: 9070067 <table border="1"> <thead> <tr><th>Colour</th><th>Code</th></tr> </thead> <tbody> <tr><td>Black</td><td>BB</td></tr> <tr><td>Red</td><td>RR</td></tr> <tr><td>Blue</td><td>UU</td></tr> </tbody> </table>	Colour	Code	Black	BB	Red	RR	Blue	UU
Colour	Code																																																																				
Black	BB																																																																				
Green	GG																																																																				
Brown	NN																																																																				
Purple	PP																																																																				
Red	RR																																																																				
Orange	TT																																																																				
Yellow	YY																																																																				
Colour	Code																																																																				
Black	BB																																																																				
Green	GG																																																																				
Pink	KK																																																																				
Brown/Black	NB																																																																				
Brown	NN																																																																				
Pink	PP																																																																				
Red/Black	RB																																																																				
Red	RR																																																																				
Red/Orange	RT																																																																				
Slate	SS																																																																				
Orange	TT																																																																				
Blue	UU																																																																				
White	WW																																																																				
Yellow	YY																																																																				
Colour	Code																																																																				
Black	BB																																																																				
Green	GG																																																																				
Red	RR																																																																				
Blue	UU																																																																				
Yellow	YY																																																																				
Colour	Code																																																																				
Black	BB																																																																				
Red	RR																																																																				
Blue	UU																																																																				
		50/0.25mm 2.5mm² Part number: 9070065 <table border="1"> <thead> <tr><th>Colour</th><th>Code</th></tr> </thead> <tbody> <tr><td>Black</td><td>BB</td></tr> <tr><td>Red</td><td>RR</td></tr> </tbody> </table>	Colour	Code	Black	BB	Red	RR	All Thin Wall Cable is supplied on 100 mtr rolls.																																																												
Colour	Code																																																																				
Black	BB																																																																				
Red	RR																																																																				

CABLE & CONNECTORS

Booster cables.

Fully insulated.
Complete with crocodile clips.
Length:- 5 metres.



Description	Part No.
110 amp	9994040
170 amp	9994045
240 amp	9994046

Surge protector.

Available in 12v or 24v.
Protects vehicles from power surges during jump starting.
For use with booster cables.



Description	Part No.
12v	BSPSSC12
24v	BSPSSC24

Booster cable clip.

Rated at 150 amps.
Available in **black** or **red**.



Description	Part No.
Black	9994041
Red	9994042

Battery terminal cover.

Polyvinylchloride (PVC).



Description	Part No.
Red	9994043
Blue	9994044

CABLE & CONNECTORS

Battery terminal.

To suit cable sizes:- 25mm² - 40mm².

Description	Part No.
Positive +	9994030
Negative -	9994031



Battery terminal.

To suit cable size:- 60mm².

Description	Part No.
Positive +	9994032
Negative -	9994033

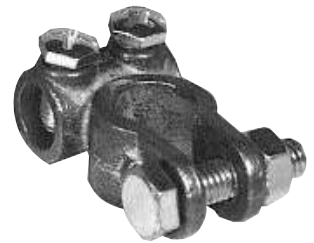

Battery terminal.

Suitable for some Japanese vehicles fitted with batteries with smaller posts.

To suit cable sizes:- 20mm² - 25mm².

Description	Part No.
Positive +	9994036
Negative -	9994037

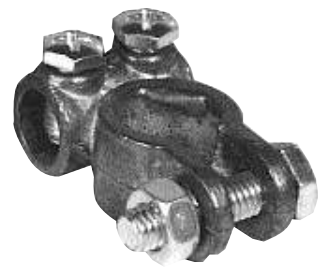

Battery terminal conversion lug.

Converts from standard taper posts to 8mm dia. stud.

Description	Part No.
Positive +	9994038
Negative -	9994039



CABLE & CONNECTORS

Battery terminal conversion lug.

Converts from standard taper posts to 10mm dia. stud.



Description	Part No.
Positive +	9994034
Negative -	9994035

9071435

Assorted heat shrink kit.

Approx 70 pieces.

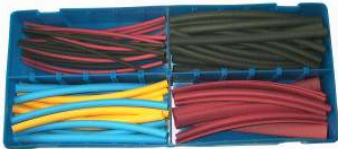

Contents
3.2mm x 150mm black
3.2mm x 150mm red
6.4mm x 150mm black

Contents
6.4mm x 150mm yellow
6.4mm x 150mm blue
9.5mm x 150mm red

9071437

Assorted pin & mouldings kit.

Approx 130 pieces.



Contents
3mm pin terminals
3mm sckt 3mm cable
3mm sckt 0.7mm cable
1 pin moulding
2 pin moulding
3 pin moulding
4 pin moulding
5 pin moulding
7 pin moulding

Contents
9 pin moulding
1 socket moulding
2 socket moulding
3 socket moulding
4 socket moulding
5 socket moulding
7 socket moulding
9 socket moulding

9071422

Assorted bullet & connector kit.

Approx 130 pieces.



Contents
2 way connector
4 way connector
10 way connector

Contents
1mm crimp bullet
2mm crimp bullet
3mm solder bullet



CABLE & CONNECTORS

Assorted terminals/covers kit.

[9071438](#)

Non-insulated.
Approx 265 pieces.

Contents
2 amp speaker
3/16" female
3/16" cover
1/4" male
1/4" female
1/4" cover

Contents
1/4" piggyback
1/4" rt/ang female
1/4" rt/ang cover
35 amp female
35 amp cover
2.8mm male lock in



Assorted red ring & fork terminal kit.

[9071423](#)

Approx 240 pieces.

Contents
3.2mm ring
3.5mm ring
4.3mm ring
5.3mm ring
6.4mm ring

Contents
8.4mm ring
10.5mm ring
3mm fork
3.5mm fork
5mm fork

Assorted red terminal kit.

[9071416](#)

Approx 480 pieces.

Contents
6.4mm male
6.4mm female
6.4mm female F.I.
Speaker terminal
Butt
1/4 piggyback

Contents
ADLOC
Bullet
Socket
3/16" female
5.3mm ring

Assorted blue/red terminal kit.

[9071419](#)

Approx 530 pieces.

Contents
6.4mm blue male
6.4mm blue female
6.4mm blue female F.I.
Blue butt
Blue socket
Blue bullet

Contents
Blue piggyback
6.4mm red male
6.4mm red female F.I.
Red butt
Red socket
Red bullet



CABLE & CONNECTORS

[9071421](#)



Assorted blue ring & fork terminal kit.

Approx 240 pieces.

Contents
3.2mm ring
4.3mm ring
5.3mm ring
6.4mm ring
8.4mm ring

Contents
10.5mm ring
3.5mm fork
4.3mm fork
5mm fork
6.4mm fork

[9071418](#)

Assorted blue terminal kit.

Approx 470 pieces.

Contents
6.4mm male
6.4mm female
6.4mm female F.I.
Butt
ADLOC
Bullet

Contents
Socket
3/16" female
5.3mm ring
6.4mm ring
6.4mm piggyback

[9071420](#)

Assorted yellow ring & fork terminal kit.

Approx 240 pieces.

Contents
4.3mm ring
5mm ring
6.4mm ring
8.4mm ring
10.5mm ring

Contents
12mm ring
4.3mm fork
5mm fork
6.4mm fork

[9071413](#)



Assorted terminal kit.

Pre-insulated terminals.
Pack of 120.

Contents
Red butt
6.4mm red male lucar
6.4mm red female lucar
Red male bullet
Red female bullet
Blue butt

Contents
6.4mm blue male lucar
6.4mm blue female lucar
Blue male bullet
Blue female bullet
6.4mm yellow male lucar
6.4mm yellow female lucar



CABLE & CONNECTORS

Ratchet crimping tool.

Suitable for pre-insulated terminals.

[9071401](#)



Cable stripping tool.

Incorporates cutter & crimper.
Suitable for cables up to 4mm.

[9071402](#)



CABLE & CONNECTORS

CONNECTORS

TYPE	SIZE	RED	BLUE	YELLOW	TYPE	
	3.50mm ring terminal	9071111	9071204	-----		
	4.30mm ring terminal	9071112	9071219	9071306		
	5.00mm ring terminal	9071113	9071220	9071307		
	6.00mm ring terminal	9071114	9071221	9071308		
	8.00mm ring terminal	9071115	9071222	9071309		
	10.00mm ring terminal	9071116	9071223	9071310		
	13.00mm ring terminal	-----	-----	9071303		
	Self stripping connector*	9071053	9071050	9071051		
	Butt connector*	9071107	9071214	9071304		
	4.00mm male bullet	9071108	9071202	-----		
	4.00mm female bullet*	9071109	9071201	-----		
	5.00mm male bullet	-----	9071211 9071216**	9071313		
	5.00mm female bullet*	-----	9071215	9071312		
	1.90mm pin connector	9071110	9071217	-----		
	2.50mm female lucar	9071103	-----	-----		
	4.80mm female lucar	9071104	9071210	-----		
	6.40mm female lucar	9071100	9071205 9071212**	9071301		
	8.00mm female lucar*	-----	9071213	-----		
	9.50mm female lucar	-----	-----	9071302		
	4.80mm female lucar*	9071106	9071203	-----		
	6.40mm female lucar*	9071105	9071200	9071300		
	6.40mm male lucar	9071102	9071207	9071311		
	6.40mm piggyback lucar	9071101	9071206	-----		
	3.20mm fork	9071117	9071224	-----		
	4.00mm fork	9071118	9071208	-----		
	4.30mm fork	-----	9071225	-----		
	5.00mm fork	9071119	9071209	-----		
	5.30mm fork	-----	9071226	-----		
* = Fully insulated		Cable Size 0.5mm - 1.5mm 9's - 16's	Cable Size 1.5mm - 2.5mm 21's - 35's	Cable Size 3mm - 6mm 44's - 65's		
** = Anti-vibration						



CABLE & CONNECTORS

HEAT SHRINK SLEEVING

PART NO.	SIZE	
9089000	3.2mm - 1.6mm	Operating temperature -55 to +135 °C Shrink temperature 100 °C Shrinks to half the original size Colour - Black Minimum order length = 1 metre
9089001	4.8mm - 2.4mm	
9089002	6.4mm - 3.2mm	
9089003	9.5mm - 4.75mm	
9089004	12mm - 6mm	
9089005	19mm - 9.5mm	
9089006	25.4mm - 12.7mm	

PVC SLEEVING

PART NO.	SIZE	
9089012	4mm	Supplied on 100 metre roll
9089013	5mm	Supplied on 100 metre roll
9089014	6mm	Supplied on 100 metre roll
9089015	7mm	Supplied on 100 metre roll
9089016	8mm	Supplied on 100 metre roll
9089017	9mm	Supplied on 100 metre roll
9089018	10mm	Supplied on 100 metre roll
9089019	11mm	Supplied on 25 metre roll
9089020	12mm	Supplied on 25 metre roll
9089021	13mm	Supplied on 25 metre roll
9089022	14mm	Supplied on 25 metre roll
9089023	15mm	Supplied on 25 metre roll
9089024	16mm	Supplied on 25 metre roll
9089025	17mm	Supplied on 25 metre roll
9089026	18mm	Supplied on 25 metre roll
9089027	19mm	Supplied on 25 metre roll
9089028	20mm	Supplied on 25 metre roll
9089029	21mm	Supplied on 25 metre roll
9089030	22mm	Supplied on 25 metre roll
9089031	25mm	Supplied on 25 metre roll

CABLE & CONNECTORS

COLOURED PVC TAPE

PART NO.	COLOUR	
9994020	Black	All PVC tape is 19mm x 20m per roll.
9994021	Blue	
9994022	Brown	
9994023	Green	
9994024	Red	
9994025	White	
9994026	Yellow	

CABLE TIES

PART NO.	SIZE	
9994000	100mm x 2.5mm Black pk 100	<p>We can label your cable ties with your company name at no extra cost.</p> <p>A. N. Other Auto Electrics Tel: (01234) 567890 Fax: (01234) 098756 Part no. 9994000 Description - Cable ties Qty - 100</p> <p>N.B. Minimum order qty for labelled packets is 20 pkts of one part number.</p>
9994001	160mm x 4.8mm Black pk 100	
9994002	200mm x 2.5mm Black pk 100	
9994003	140mm x 3.6mm Black pk 100	
9994004	200mm x 4.8mm Black pk 100	
9994005	300mm x 4.8mm Black pk 100	
9994006	370mm x 4.8mm Black pk 100	
9994007	370mm x 7.6mm Black pk 100	
9994008	290mm x 7.6mm Black pk 100	
9994009	370mm x 4.8mm Silver pk 100	

CABLE TIE BASES

PART NO.	SIZE	
9994010	19mm x 19mm	
9994011	25mm x 25mm	

CABLE & CONNECTORS

Conduit.

Flexible & lightweight polyimide (PA6) conduit. PA6 material provides fire retardant properties & halogen free emissions.

Supplied in split form to facilitate rapid cable installation or unsplit form to provide protection against mechanical shock & ingress of water. Suitable for automotive applications & harness fabrication.

Enhanced flexibility enabling ease of use in confined spaces.

Operating temperature range, continuous -40°C to +120°C, intermittent -40°C to +150°C.

Rated to IP67* with sealed fittings (except split) & rated to IP40* with hinged fittings (except split).

Supplied in 25mtr rolls.



Split/Unsplit	Overall (A)	Min. Bore (B)	Bend Radius (C)	Part No.
Split	10.0mm	6.9mm	10	9090000
Split	13.0mm	10.1mm	18	9090001
Split	16.0mm	11.8mm	32	9090002
Split	18.5mm	14.5mm	35	9090003
Split	21.2mm	16.9mm	40	9090004
Unsplit	10.0mm	6.9mm	10	9090005
Unsplit	13.0mm	10.1mm	18	9090006
Unsplit	16.0mm	11.8mm	32	9090007
Unsplit	21.2mm	16.9mm	40	9090008

*See IP ratings guide (page 192).

T-piece conduit fitting (hinged).

Designed to snap together over different types of split & unsplit conduit thus maintaining maximum bore.

Operating temperature range, continuous -40°C to +120°C, intermittent -40°C to +150°C.

Rated to IP40*.

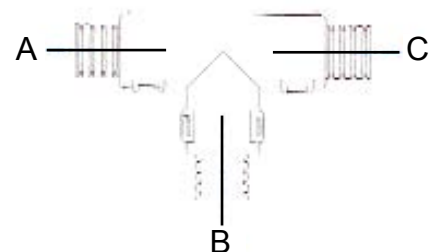

A	B	C	Part No.
8mm	8mm	8mm	9091004
12mm	12mm	12mm	9091005
16mm	16mm	16mm	9091006
20mm	20mm	16mm	9091007

*See IP ratings guide (page 192).

CABLE & CONNECTORS

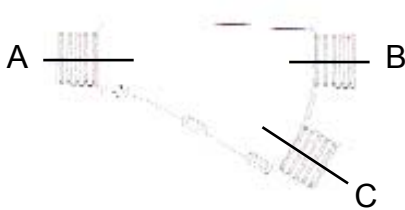

Y-piece conduit fitting (hinged).

Designed to snap together over different types of split & unsplit conduit thus maintaining maximum bore.
Operating temperature range, continuous -40°C to +120°C, intermittent -40°C to +150°C.
Rated to IP40*.

A	B	C	Part No.
8mm	8mm	8mm	9091008
12mm	12mm	12mm	9091009
16mm	16mm	12mm	9091010
20mm	16mm	16mm	9091011

*See IP ratings guide (page 192).

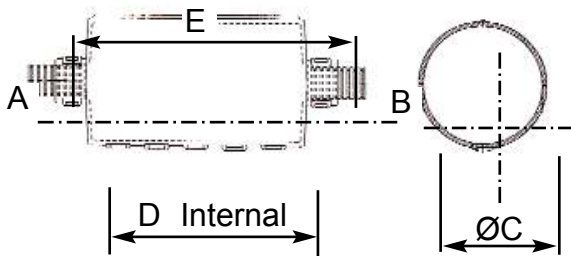

Shroud conduit fitting (hinged).

Designed to snap together over different types of split & unsplit conduit thus maintaining maximum bore.
Provides protection for inline connectors, fuse links, circuit breakers & splicing areas.
Operating temperature range, continuous -40°C to +120°C, intermittent -40°C to +150°C.
Rated to IP40*.

A	B	C	D	E	Part No.
12mm	12mm	43mm	77mm	100mm	9091012
16mm	16mm	43mm	77mm	104mm	9091013
12mm	12mm	35mm	73mm	100mm	9091014
16mm	20mm	43mm	77mm	104mm	9091015
20mm	20mm	43mm	77mm	104mm	9091016

*See IP ratings guide (page 192).

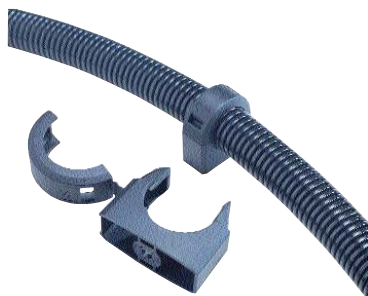

Clip conduit fitting (hinged).

Designed to snap together over different types of split & unsplit conduit.
Non metallic clip provides secure mounting points for conduit systems within a harness installation.
Operating temperature range, continuous -40°C to +120°C, intermittent -40°C to +150°C.
Rated to IP40*.

Conduit Size	Part No.
20mm	9091019
16mm	9091020

*See IP ratings guide (page 192).



CABLE & CONNECTORS

Gland.

Straight compression fittings incorporating fixed male threads to provide connection to knockouts and threaded entries. Suitable for up to 12mm conduit. Sealing bush rated to IP67*.

NOTE: order body, nuts, locknuts & bushes separately (not supplied as complete unit).

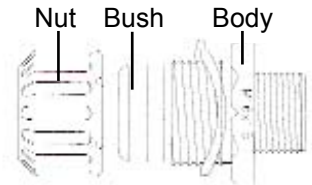

Thread Size	Body	Nut	Locknut	Bush
M16 x 1.5	9091000	9091001	9091003	9091002

*See IP ratings guide (page 192).

Enclosure.

Non metallic enclosure designed for use as a multi-way junction box or as a component or terminal housing. This enclosure provides the facility for quick and simple connection to our sealed fittings & glands via PG sized knockouts. Sealing gasket rated to IP66*. Polycarbonate construction provides UV resistant properties and halogen free emissions.



W	D	H	Part No.
94mm	94mm	57mm	9091017
110mm	110mm	66mm	9091018

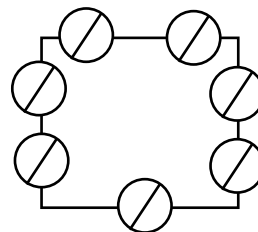

9091017 knockout arrangement with PG11/16 holes.

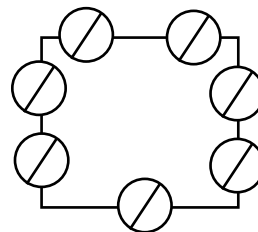

9091018 knockout arrangement with PG16/21 holes.

*See IP ratings guide (page 192).

JUNCTION BOXES

[111/01/01](#)



Rubbolite®

Junction box.

Plastic construction with transparent lid.
4 rubber cable entries can be cut to various sizes.
Complete with **8 way** terminal block & fixing screws.
Box can be used (without the terminal block) as a fuse box or terminal connection cover.
Size:- 145mm (L) x 101mm (W) x 37mm (D).

[111/01/00](#)



Rubbolite®

Junction box.

Plastic construction with transparent lid.
4 rubber cable entries can be cut to various sizes.
Complete with fixing screws.
Terminal block not included.
Box can be used as a fuse box or terminal connection cover.
Size:- 145mm (L) x 101mm (W) x 37mm (D).

[111/01/02](#)



Rubbolite®

Junction box.

Plastic construction with transparent lid.
4 rubber cable entries can be cut to various sizes.
Complete with **2 x 8 way** terminal blocks & fixing screws.
Box can be used (without the terminal blocks) as a fuse box or terminal connection cover.
Size:- 145mm (L) x 101mm (W) x 37mm (D).

[111/07/00](#)



Rubbolite®

Junction box.

Plastic construction with transparent lid.
8 rubber cable entries can be cut to various sizes.
Complete with fixing screws.
Terminal block not included.
Box can be used as a fuse box or terminal connection cover.
Size:- 145mm (L) x 101mm (W) x 70mm (D).

JUNCTION BOXES

Junction box.

Plastic construction with transparent lid.
8 rubber cable entries can be cut to various sizes.
Complete with **8 way** terminal block & fixing screws.
Box can be used (without the terminal block) as a fuse box or terminal connection cover.
Size:- 145mm (L) x 101mm (W) x 70mm (D).

[111/07/01](#)



Rubbolite[®]

Junction box.

Natural rubber construction with transparent lid.
4 rubber cable entries can be cut to various sizes.
Complete with heavy duty **8 way** terminal block & fixing screws.
Box can be used (without the terminal block) as a fuse box or terminal connection cover.
Size:- 102mm (L) x 74mm (W) x 38mm (D).

[108/01/00](#)



Rubbolite[®]

Junction box.

Impact resistant plastic construction.
16 pre-formed cable grommets will accept 2 core flat or round, 4/5 core, 7 core & 10 core.
Complete with **16 way** terminal block with type 250 spade terminals.
Hinged lid incorporates wiring label.
Rated to IP5*, IP6* & IPx 9K (water/pressure washing).
Size:- 146mm (L) x 98mm (W) x 87mm (D).

[120/07/02](#)



Rubbolite[®]

*See IP ratings guide (page 192).

Junction box.

Plastic construction with transparent lid.
6 rubber cable entries can be cut to various sizes.
Complete with **10 way** terminal block & fixing screws.
Box can be used (without the terminal block) as a fuse box or terminal connection cover.
Size:- 156mm (L) x 78mm (W) x 50mm (D).

[9980002](#)



FUSES, FUSE BOXES/HOLDERS & CIRCUIT BREAKERS

Mini blade fuse.

Packs of 10.

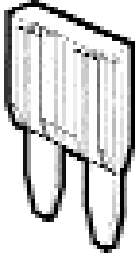

Description	Part No.
3 Amp	9071000.03
4 Amp	9071000.04
5 Amp	9071000.05
10 Amp	9071000.10

Description	Part No.
15 Amp	9071000.15
20 Amp	9071000.20
25 Amp	9071000.25
30 Amp	9071000.30

Standard blade fuse.

Packs of 10.



Description	Part No.
1 Amp	9071003.01
2 Amp	9071003.02
3 Amp	9071003.03
4 Amp	9071003.04
5 Amp	9071003.05
7 Amp	9071003.07

Description	Part No.
10 Amp	9071003.10
15 Amp	9071003.15
20 Amp	9071003.20
25 Amp	9071003.25
30 Amp	9071003.30

Maxi blade fuse.

Packs of 2.

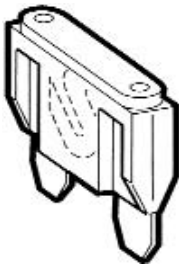

Description	Part No.
10 Amp	9071004.10
20 Amp	9071004.20
30 Amp	9071004.30
40 Amp	9071004.40
50 Amp	9071004.50

Description	Part No.
60 Amp	9071004.60
70 Amp	9071004.70
80 Amp	9071004.80
100 Amp	9071004.100

PAL female fuse.

Supplied in singles.

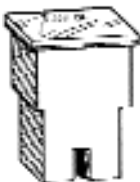

Description	Part No.
30 Amp	9071005.30
40 Amp	9071005.40
60 Amp	9071005.60
80 Amp	9071005.80



FUSES, FUSE BOXES/HOLDERS & CIRCUIT BREAKERS

PAL male fuse.

Supplied in singles.

Description	Part No.
30 Amp	9071006.30
40 Amp	9071006.40
60 Amp	9071006.60
80 Amp	9071006.80



PAL shortleg fuse.

Supplied in singles.

Description	Part No.
30 Amp	9071007.30
40 Amp	9071007.40
60 Amp	9071007.60
80 Amp	9071007.80
100 Amp	9071007.100

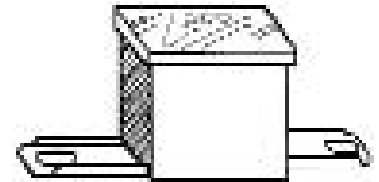

Radio fuse.

Packs of 10.

Size:- 19mm (L) x 5mm (dia.).

Description	Part No.
2 Amp	9071001.02
3 Amp	9071001.03
5 Amp	9071001.05



Glass fuse.

Packs of 10.

Size:- 29mm (L) x 6mm (dia.).

Description	Part No.
1 Amp	9071002.01
2 Amp	9071002.02
3 Amp	9071002.03
5 Amp	9071002.05
7 Amp	9071002.07
10 Amp	9071002.10

Description	Part No.
15 Amp	9071002.15
20 Amp	9071002.20
25 Amp	9071002.25
35 Amp	9071002.35
50 Amp	9071002.50

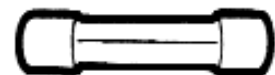

FUSES, FUSE BOXES/HOLDERS & CIRCUIT BREAKERS

Domestic fuse.

Packs of 10.
Size:- 25mm (L) x 6mm (dia.).



Description	Part No.
3 Amp	9071008.03
5 Amp	9071008.05
13 Amp	9071008.13

Ceramic fuse.

Packs of 10.
Size:- 26mm (L) x 6mm (dia.).



Description	Part No.
5 Amp	9071009.05
8 Amp	9071009.08
16 Amp	9071009.16
25 Amp	9071009.25

Strip link fuse.

Packs of 10.
Length:- 41mm.

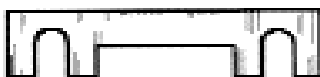

Description	Part No.
30 Amp	9071010.30
40 Amp	9071010.40
50 Amp	9071010.50
60 Amp	9071010.60
80 Amp	9071010.80

[9071428](#)

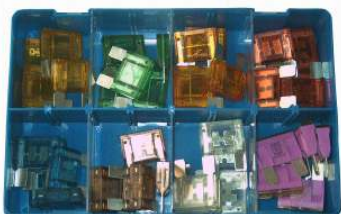

Assorted maxi blade fuse kit.

Approx 40 pieces.

Contents
20 Amp
30 Amp
40 Amp
50 Amp

Contents
60 Amp
70 Amp
80 Amp
100 Amp

FUSES, FUSE BOXES/HOLDERS & CIRCUIT BREAKERS

Assorted standard blade fuse kit.

[9071410](#)

Approx 120 pieces.

Contents
3 Amp
4 Amp
5 Amp
7.5 Amp
10 Amp

15 Amp
20 Amp
25 Amp
30 Amp



Assorted mini blade fuse kit.

[9071412](#)

Approx 120 pieces.

Contents
3 Amp
4 Amp
5 Amp
7.5 Amp
10 Amp

Contents
15 Amp
20 Amp
25 Amp
30 Amp



Assorted glass fuse kit.

[9071411](#)

Approx 120 pieces.

Contents
1 Amp
1.5 Amp
2 Amp
3 Amp
5 Amp
8 Amp

Contents
10 Amp
15 Amp
20 Amp
25 Amp
35 Amp
50 Amp

Assorted DIN fuse kit.

[9071429](#)

Approx 600 pieces.

Contents
1 Amp
2 Amp
3 Amp

Contents
5 Amp
10 Amp



FUSES, FUSE BOXES/HOLDERS & CIRCUIT BREAKERS

Circuit breaker.

Suitable for all 12-24v applications.

Press to reset.

For holder use **9071065** (see **page 58**).

Can be used to replace a standard blade fuse.



Description	Part No.
6 Amp	9071011.06
8 Amp	9071011.08
10 Amp	9071011.10

Description	Part No.
15 Amp	9071011.15
20 Amp	9071011.20
25 Amp	9071011.25

Compact circuit breaker.

Suitable for all 12-24v applications.

Press to reset.

For holder use **9071065** (see **page 58**).

Can be used to replace a standard blade fuse.



Description	Part No.
6 Amp	9071012.06
8 Amp	9071012.08
10 Amp	9071012.10

Description	Part No.
15 Amp	9071012.15
20 Amp	9071012.20
25 Amp	9071012.25

Circuit breaker.

Suitable for all 12-24v applications.

For panel mounting in 9.6mm dia. hole.

Solder terminals.

Press to reset.



Description	Part No.
5 Amp	9071013.05
7 Amp	9071013.07
10 Amp	9071013.10

Description	Part No.
15 Amp	9071013.15
20 Amp	9071013.20
25 Amp	9071013.25

Circuit breaker.

Suitable for all 12-24v applications.

For panel mounting in 9.6mm dia. hole.

Solder terminals.

Manual trip.

Press to reset.



Description	Part No.
5 Amp	9071014.05
7 Amp	9071014.07
10 Amp	9071014.10

Description	Part No.
15 Amp	9071014.15
20 Amp	9071014.20
25 Amp	9071014.25



FUSES, FUSE BOXES/HOLDERS & CIRCUIT BREAKERS

Circuit breaker.

Suitable for **12-24v** applications.
For panel mounting in 9mm dia. hole.
Press to reset.
Lucar terminals.

Description	Part No.
5 Amp	9071015.05
10 Amp	9071015.10
15 Amp	9071015.15

Description	Part No.
20 Amp	9071015.20
30 Amp	9071015.30



Rocker switch with circuit breaker.

On/off, latching.
8 amp circuit breaker incorporated.
Fixing:- 45mm (H) x 22mm (W) aperture required.
Lucar terminals.

[9996015](#)

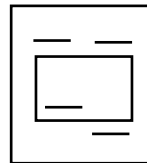

Circuit breaker holder.

Suitable for **9071011** & **9071012** series circuit breakers (see [page 57](#)).

[9071065](#)



Fuse holder.

With terminals.
Accepts 28/0.3mm (2mm²) cable.
Takes glass type fuses.
Rated at **17.5 amps** continuous.

[9071060](#)

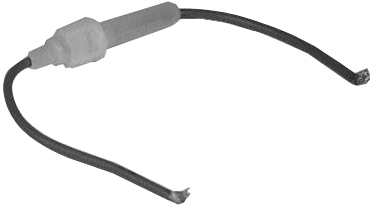

FUSES, FUSE BOXES/HOLDERS & CIRCUIT BREAKERS[9071061](#)***Fuse holder.***

Without terminals.
Accepts 28/0.3mm (2mm²) cable.
Takes glass type fuses.
Rated at **17.5 amps** continuous.

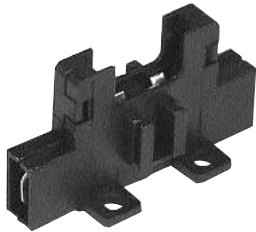
[9071062](#)***Fuse holder.***

Takes standard blade type fuses.
Rated at **30 amps** continuous.

[9071063](#)***Fuse holder.***

Takes mini blade type fuses.
Splash proof.
Rated at **15 amps** continuous.

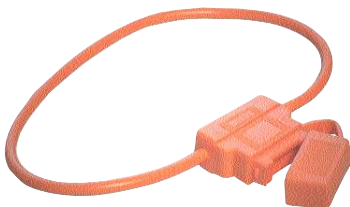
[9071064](#)***Fuse holder.***

Takes standard blade type fuses.
Splash proof.
Rated at **30 amps** continuous.



FUSES, FUSE BOXES/HOLDERS & CIRCUIT BREAKERS

Continental ceramic fuse holder.

[9071066](#)

Screw terminals.
Complete with **8 amp** fuse.



Fuse box.

[9997054](#)

Takes standard blade type fuses.
8 way.
Complete with cover & gasket.
2 hole fixing.
Lucar terminals.
Fuses not included.

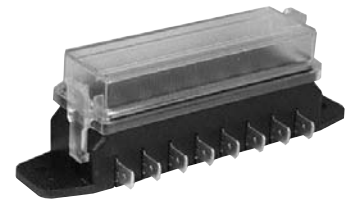

Fuse box.

[9997055](#)

Takes standard blade type fuses.
16 way.
Complete with cover & gasket.
4 hole fixing.
Crimp terminals.
Fuses not included.



Fuse box.

[9997050](#)

Takes standard blade type fuses.
4 way.
Complete with cover.
2 hole fixing.
Lucar terminals.
Fuses not included.



FUSES, FUSE BOXES/HOLDERS & CIRCUIT BREAKERS[9997051](#)***Fuse box.***

Takes standard blade type fuses.

6 way.

Complete with cover.

2 hole fixing.

Lucar terminals.

Fuses not included.

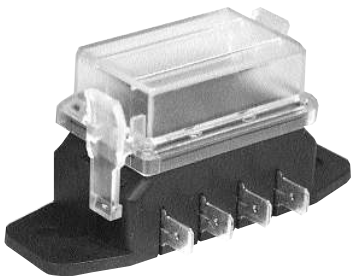
[9997052](#)***Fuse box.***

Takes standard blade type fuses.

4 way.

Complete with cover & gasket.

2 hole fixing.

Lucar terminals.

Fuses not included.

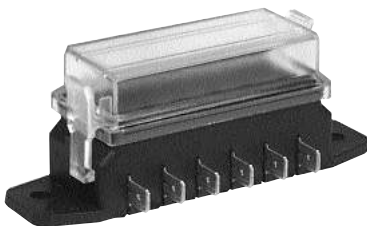
[9997053](#)***Fuse box.***

Takes standard blade type fuses.

6 way.

Complete with cover & gasket.

2 hole fixing.

Lucar terminals.

Fuses not included.

[9997057](#)***Fuse box.***

Takes standard blade type fuses.

12 way.

Complete with cover.

2 hole fixing.

Lucar terminals.

Fuses not included.

FUSES, FUSE BOXES/HOLDERS & CIRCUIT BREAKERS

Fuse box.

Takes continental type ceramic fuses.

4 way.

Complete with cover.

2 hole fixing.

Screw terminals.

Fuses not included.

[9997058](#)



Fuse box.

Takes continental type ceramic fuses.

6 way.

Complete with cover.

2 hole fixing.

Screw terminals.

Fuses not included.

[9997059](#)



Fuse box.

Takes continental type ceramic fuses.

8 way.

Complete with cover.

2 hole fixing.

Screw terminals.

Fuses not included.

[9997060](#)



Fuse box.

Takes continental type ceramic fuses.

12 way.

Complete with cover.

2 hole fixing.

Screw terminals.

Fuses not included.

[9997061](#)



FUSES, FUSE BOXES/HOLDERS & CIRCUIT BREAKERS**9997056*****Circuit breaker box.***

Takes standard blade
type circuit breakers.

6 way.

Complete with cover
& gasket.

2 hole fixing.

Lucar terminals.

Circuit breakers not included.





TOWING & TOURING

TOWING

Plug (12N).

Plastic body.
7 brass pins
(4 male & 3 female).
Screw terminals.
Rated to ISO 1724.
For use with **9998001**
(see **page 73**) & **9998002**
(see **page 74**).

[9998004](#)



Plug (12S).

Plastic body.
7 brass pins
(5 male & 2 female).
Screw terminals.
Rated to ISO 3732.
For use with **9998011**
(see **page 73**).

[9998010](#)



Plug (12N).

Aluminium body.
7 brass pins
(4 male & 3 female).
Screw terminals.
Rated to ISO 1724.
For use with **9998001**
(see **page 73**) & **9998002**
(see **page 74**).

[9998003](#)



Plug.

Nickel plated body.
3 male pins.
Screw terminals.
Rated at **5 amps** continuous.
For use with **9998027**
(see **page 73**).

[9998026](#)



TOWING

9998034



Plug.

Zinc alloy body.
1 male silver plated pin.
Screw terminals.
Rated at **300 amps** continuous,
400 amps intermittent.
For use with **9998040**
(see page 73).

9998005

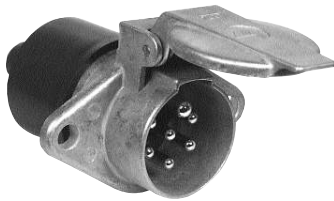

Plug (24N).

Aluminium body.
7 male nickel plated brass pins.
Screw terminals.
Complete with rubber cover.
Rated to ISO 1185, DIN 72579.
For use with **9998007**
(see page 71).

Spares	Description	Part No.
	Rubber cover	9998009

9998006



Plug (24S).

Aluminium body.
7 nickel plated brass pins
(6 male & 1 female).
Screw terminals.
Complete with rubber cover.
Rated to ISO 3731.
For use with **9998008**
(see page 72).

Spares	Description	Part No.
	Rubber cover	9998009

9998019

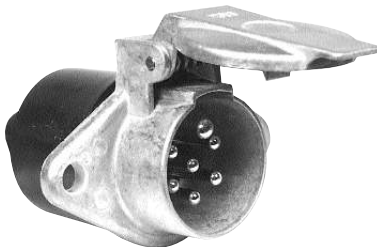

Plug (24N).

Aluminium body.
7 male nickel plated brass pins.
Lucar terminals.
Complete with rubber cover.
Rated to ISO 1185, DIN 72579.
For use with **9998007**
(see page 71).

Spares	Description	Part No.
	Rubber cover	9998009

TOWING

Plug (24S).

Aluminium body.
 7 nickel plated brass pins
 (6 male & 1 female).
 Lucar terminals.
 Complete with rubber cover.
 Rated to ISO 3731.
 For use with **9998038**
 (see **page 72**).

[9998039](#)

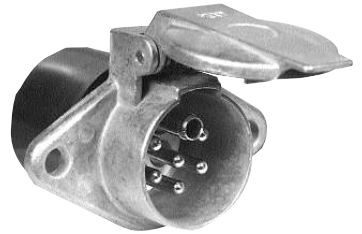

Spares	Description	Part No.
	Rubber cover	<u>9998009</u>

Plug (24N).

Zinc alloy body.
 7 male nickel plated brass pins.
 Screw terminals.
 Rated at **30 amps** continuous.
 Rated to ISO 1185.
 For use with **9998036**
 (see **page 72**).

[9998035](#)



Plug (24S).

Zinc alloy body.
 7 nickel plated brass pins
 (6 male & 1 female).
 Screw terminals.
 Rated at **30 amps** continuous.
 Rated to ISO 3731.
 For use with **9998038**
 (see **page 72**).

[9998037](#)

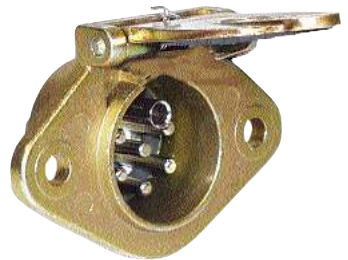

Plug.

Zinc alloy body.
 3 male nickel plated brass pins.
 Screw terminals.
 Rated at **25 amps** continuous,
45 amps intermittent.
 For use with **9998031**
 (see **page 71**).

[9998030](#)



TOWING

[9998028](#)

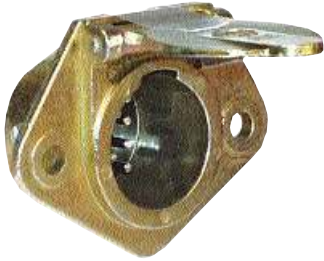

Plug.

Zinc alloy body.
10 male nickel plated brass pins.
Screw terminals.
For use with **9998029**
(see **page 71**).

[9998032](#)

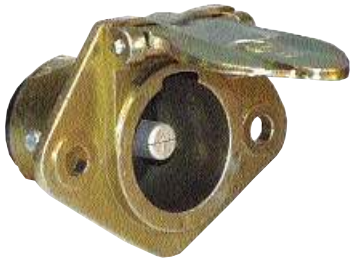

Plug.

Zinc alloy body.
1 male silver plated pin.
Screw terminals.
Rated at **300 amps** continuous,
400 amps intermittent.
For use with **9998033**
(see **page 72**).

[9998017](#)



ABS Plug.

Thermoplastic body.
5 male pins.
Screw terminals.
Rated to ISO 7638-1.
For use with **9998016**
(see **page 74**).

[9998047](#)

Electronic Braking System (EBS) Plug (24v).

Thermoplastic body.
7 male nickel plated brass pins.
Screw terminals.
Rated to ISO/DIN 7638-1.
For use with **9998046**
(see **page 74**).



TOWING

Electronic Braking System (EBS) Plug (24v).

[9998059](#)

Thermoplastic body.
15 male nickel plated brass pins.
Screw terminals.
Rated to ISO 12098, DIN 72570.
For use with **9998018** &
9998058 (see **page 75**).



Socket.

[9998029](#)

Zinc alloy body.
10 female nickel plated brass pins.
Screw terminals.
For use with **9998028**
(see **page 70**).

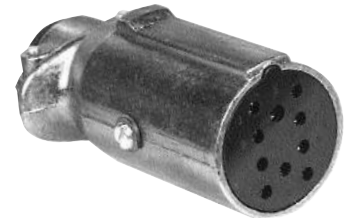

Socket.

[9998031](#)

Zinc alloy body.
3 female nickel plated brass pins.
Screw terminals.
Rated at **25 amps** continuous,
45 amps intermittent.
For use with **9998030**
(see **page 69**).

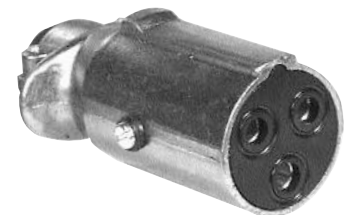

Socket (24N).

[9998007](#)

Aluminium body.
7 female nickel plated brass pins.
Screw terminals.
Rated to ISO 1185, DIN 72579.
For use with **9998019**
(see **page 68**).



TOWING

[9998008](#)



Socket (24S).

Aluminium body.
7 nickel plated brass pins
(1 male & 6 female).
Screw terminals.
Rated to ISO 3731.
For use with **9998006**
(see **page 68**).

[9998036](#)



Socket (24N).

Zinc alloy body.
7 female nickel plated brass pins.
Screw terminals.
Rated at **30 amps** continuous.
Rated to ISO 1185.
For use with **9998035**
(see **page 69**).

[9998038](#)



Socket (24S).

Zinc alloy body.
7 nickel plated brass pins
(1 male & 6 female).
Screw terminals.
Rated at **30 amps** continuous.
Rated to ISO 3731.
For use with **9998037**
(see **page 69**).

[9998033](#)



Socket.

Zinc alloy body.
1 female silver plated pin.
Screw terminals.
Rated at **300 amps** continuous,
400 amps intermittent.
For use with **9998032**
(see **page 70**).



TOWING

Socket.

Nickel plated body.
3 female pins.
Screw terminals.
Rated at **5 amps** continuous.
For use with **9998026**
(see **page 67**).

[9998027](#)



Socket.

Zinc alloy body.
1 female silver plated pin.
Screw terminals.
Rated at **300 amps** continuous,
400 amps intermittent.
For use with **9998034**
(see **page 68**).

[9998040](#)



Socket (12N).

Plastic body.
7 brass pins
(3 male & 4 female).
Screw terminals.
Rated to ISO 1724.
For use with **9998004** &
9998003 (see **page 67**).

[9998001](#)



Socket (12S).

Plastic body.
7 brass pins
(2 male & 5 female).
Screw terminals.
Rated to ISO 3732.
For use with **9998010**
(see **page 67**).

[9998011](#)



TOWING

[9998002](#)



Socket (12N).

Aluminium body.
7 brass pins
(3 male & 4 female).
Screw terminals.
Rated to ISO 1724.
For use with **9998003**
(see **page 67**).

[9998041](#)



Trailing socket (12N).

Plastic body.
7 brass pins
(3 male & 4 female).
Screw terminals.
Suitable for extending lead.
Rated to ISO 1724.
For use with **9998004** &
9998003 (see **page 67**).

[9998016](#)



ABS socket.

Thermoplastic body.
5 female pins.
Screw terminals.
Rated to ISO 7638-1.
For use with **9998017**
(see **page 70**).

[9998046](#)

Electronic Braking System (EBS) Socket (24v).

Thermoplastic body.
7 female nickel plated brass pins.
Screw terminals.
Rated to ISO/DIN 7638-1.
For use with **9998047**
(see **page 70**).



TOWING

Electronic Braking System (EBS) Socket (24v).

[9998058](#)

Thermoplastic body.
15 female nickel plated brass pins.
Screw terminals.
Rated to ISO 12098, DIN 72570.
For use with **9998059**
(see **page 71**).



Adaptor socket.

[9998018](#)

Converts **15 pin** plug to
24N & 24S sockets.
Screw terminals.
For use with **9998059**
& **9998007** (see **page 71**),
9998008, **9998036**
& **9998038** (see **page 72**).



Socket and bracket assembly.

[9998012](#)

Prewired **12N** socket.
Complete with 1 metre of 7 core cable.
For use with **9998003** or **9998004**
(see **page 67**).



Socket and bracket assembly.

[9998013](#)

Prewired **12N & 12S** sockets.
Complete with 1 metre of 7 core cable.
For use with **9998003** & **9998004**
or **9998010** (see **page 67**).



TOWING

[9998021](#)



Electrical coil (ABS).

Black hytrel cable sheath.
Complete with sockets.
19 turns.
Cable rated to ISO 4141.
Sockets rated to ISO 7638-1.
Extended length:- 4.5 Metres.
For use with **9998017**
(see **page 70**).

[9998022](#)



Electrical coil (ABS).

Black hytrel cable sheath.
Complete with sockets.
14 turns.
Cable rated to ISO 4141.
Sockets rated to ISO 7638-1.
Extended length:- 3.5 Metres.
For use with **9998017**
(see **page 70**).

[9998023](#)



Electrical coil (ABS).

Black hytrel cable sheath.
Complete with sockets.
32.5 turns.
Cable rated to ISO 4141.
Sockets rated to ISO 7638-1.
Extended length:- 4.5 Metres.
For use with **9998017**
(see **page 70**).

[9998024](#)



Electrical coil.

Black nylon cable sheath.
Complete with 2 x **24N** sockets.
15 turns.
Sockets rated to ISO 1185.
Extended length:- 3.5 Metres.
For use with **9998005**
(see **page 68**) or **9998035**
(see **page 69**).

TOWING

Electrical coil.

Black polyurethane cable sheath.
Complete with **2 x 24N** sockets.
33 turns.
Sockets rated to ISO 1185,
DIN 72579.
Extended length:- 3 Metres.
For use with **9998005**
(see **page 68**) or **9998035**
(see **page 69**).

[**9998050**](#)



Electrical coil.

Black polyurethane cable sheath.
Complete with **2 x 24S** sockets.
38 turns.
Sockets rated to ISO 3731.
Extended length:- 3 Metres.
For use with **9998006**
(see **page 68**) or **9998037**
(see **page 69**).

[**9998052**](#)



Electrical coil.

Green nylon cable sheath.
Complete with **2 x 24S** sockets.
12.5 turns.
Sockets rated to ISO 3731.
Extended length:- 3.5 Metres.
For use with **9998006**
(see **page 68**) or **9998037**
(see **page 69**).

[**9998042**](#)

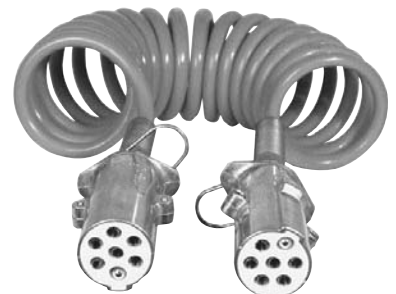

Electrical coil (EBS).

Black hytrel cable sheath.
Complete with **2 x 7 pin EBS** sockets.
19 turns.
Cable rated to ISO 4141.
Sockets rated to ISO 7638-1.
Extended length:- 4.5 Metres.
For use with **9998047**
(see **page 70**).

[**9998055**](#)



TOWING

[9998056](#)



Electrical coil (EBS).

Black hytel cable sheath.
Complete with 2 x 15 pin EBS sockets.
19 turns.
Cable rated to ISO 4141.
Sockets rated to ISO 12098.
Extended length:- 4.5 Metres.
For use with **9998059**
(see **page 71**).

[9998057](#)



Electrical coil.

Black polyurethane cable sheath.
Complete with 1 x 15 pin socket
connecting into 1 x 24N 7 pin socket
& 1 x 24S 7 pin socket.
For use with **9998059**
(see **page 71**), **9998005**
& **9998006** (see **page 68**).

[9998048](#)



Electrical coil.

Black polyurethane cable sheath.
7 core.
33 turns.
Plugs/sockets not included.
Extended length:- 3 Metres.

[9998054](#)



Electrical coil.

7 core.
12 turns.
Plugs/sockets not included.
Extended length:- 3 Metres.
Rated to SAE J8/44C.



TOWING

Mains hook up lead (240v).

Orange H05VV-F* cable.
 Suitable for caravans.
 Complete with
 plug & socket.
 Rated to **25 amps/500v**.
 Length:- 25 metres.

[9998020](#)



*H05VV-F = harmonized, 500v, PVC/PVC with fine wire construction for flexibility.

Bracket.

Galvanised & enamelled.
 Takes **12N & 12S** sockets.

Description	Part No.
Single bracket	9998014
Double bracket	9998015



Warning triangle.

Breakdown warning triangle.
 Supplied in plastic carry case.
 Conforms to IRO 2705, E9 27R 03 1003.

[9987007](#)



*UK Department of Transport regulation - When using this product directly on the road it must be used in conjunction with a road sign, e.g. a European standard warning triangle. See [9987007](#) (above).

CIGARETTE LIGHTERS AND ADAPTERS[9998065](#)***Cigarette lighter (12v).***

Complete with holder.
Illuminated.

Fits certain European cars.

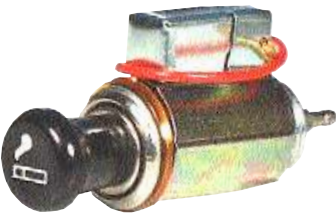
[9998066](#)***Cigarette lighter (12v).***

Complete with holder.
Illuminated.

Universal fitting.

[9998067](#)***Cigarette lighter
element (12v).***

Fits 9998065 (above).

[9998068](#)***Cigarette lighter
element (12v).***

Fits 9998066 (above).

CIGARETTE LIGHTERS AND ADAPTERS

Cigarette lighter plug (12v).

[9998069](#)

Straight cable entry.
Solder terminals.
Suitable for running auxiliary
accessories.



Cigarette lighter plug (12v).

[9998043](#)

Angled cable entry.
2 screw terminals.
Suitable for running auxiliary
accessories.
Rated to ISO 4165, DIN 72591.
Can also be used with **9998045**
(see **page 185**).



Cigarette lighter adapter (12v).

[9998060](#)

Twin socket outlet
Y adapter.
Fuse protected.
1ft extension cable
for mobility of use.
Rated at **10 amps**.



Cigarette lighter adapter (12v).

[9998061](#)

Twin socket outlet.
2 screw hole fixing.
Fuse protected.
3ft extension cable
for mobility of use.
Rated at **10 amps**.



CIGARETTE LIGHTERS AND ADAPTERS[9998062](#)***Cigarette lighter adapter (12v).***

Triple socket outlet.
2 screw hole fixing.
Fuse protected.
3ft extension cable for mobility of use.
Rated at **10 amps**.

[9998063](#)***Cigarette lighter adapter (12v).***

Twin adapter
(1 cigarette lighter & 1 socket).
Complete with double sided tape for fixing.
2ft extension cable for mobility of use.
Rated at **10 amps**.

[9998064](#)***Cigarette lighter adapter (12v).***

Twin adapter
(1 cigarette lighter & 1 socket).
Plugs directly into cigarette lighter socket.
Rated at **10 amps**.



RELAYS & FLASHER UNITS



RELAYS & FLASHER UNITS

Relay (12v).

Normally open.
Rated at **30 amps**.
4 terminal.
Complete with bracket.

[9997000](#)

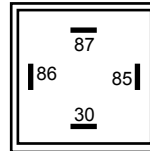

Relay (24v).

Normally open.
Rated at **20 amps**.
4 terminal.
Complete with bracket.

[9997001](#)

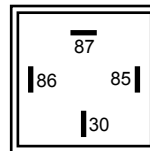

Relay (12v).

Changeover.
Rated at **20/30 amps**.
5 terminal.
Complete with bracket.

[9997002](#)

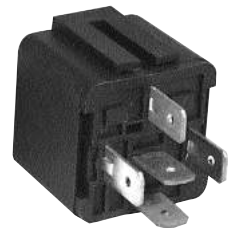
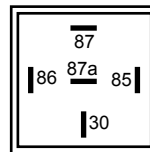

Relay (24v).

Changeover.
Rated at **10/20 amps**.
5 terminal.
Complete with bracket.

[9997003](#)

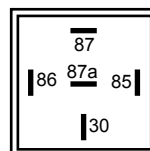

RELAYS & FLASHER UNITS

9997012

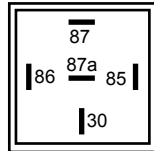

Relay (12v).

Changeover with diode across the coil.
Rated at **40 amps**.
5 terminal.
Complete with bracket.

9997004

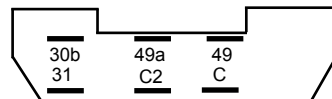

Flasher unit (24v).

2+1 x 21w x 5w.
6 x 21w.
2 screw fixing.

9997005

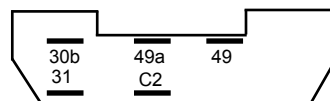

Flasher unit (24v).

2+1/6 x 21w.

9997007

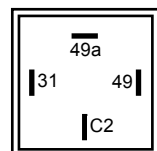

Flasher unit (12v).

2+1/6 x 21w.
Trailer/caravan hazard.



RELAYS & FLASHER UNITS

Flasher unit (12v).

2/4 x 21w.

[9997010](#)

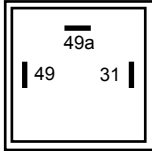

Flasher unit (24v).

2/4 x 21w.
+ 2 x 5w.
Max 98w.
Complete with bracket.

[9997009](#)

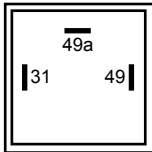

Flasher unit (24v).

2/4 x 21w.
Complete with bracket.

[9997008](#)

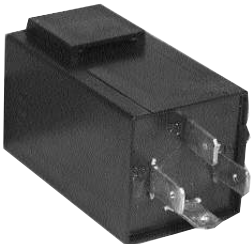
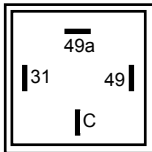

Flasher unit (12v).

2/4 x 21w + 5w.

[9997011](#)

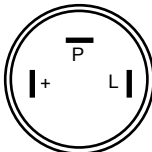

O.E.M. names and numbers are used for reference purposes only.

VOLTAGE DROPPERS

[9881014](#)



Voltage dropper.

24v - 12v.

Rated at **6 amps** continuous,
10 amps peak.

Overload & overheat protection.

Type approved to 72/245/EEC
as last amended by 95/54/EC.

Size:- 290mm (L) x 115mm (W) x 50mm (D).

[9881023](#)



Voltage dropper.

24v - 12v.

Rated at **4 amps** continuous,
7 amps peak.

Overload, reverse polarity, short
circuit & soft shutdown protection.

2 LED's to indicate operating status.

Conforms to EC 93/68/EEC,
95/54/EC & VIDG SPEC 5 ISS 7.

Size:- 69mm (L) x 74mm (W) x 31mm (D).

[9881024](#)



Voltage dropper.

24v - 12v.

Rated at **7 amps** continuous,
11 amps peak.

Overload, reverse polarity, short
circuit & soft shutdown protection.

2 LED's to indicate operating status.

Conforms to EC 93/68/EEC,
95/54/EC & VIDG SPEC 5 ISS 7.

Size:- 79mm (L) x 74mm (W) x 31mm (D).

[9881025](#)



Voltage dropper.

24v - 12v.

Rated at **10 amps** continuous,
14 amps peak.

Overload, reverse polarity, short
circuit & soft shutdown protection.

2 LED's to indicate operating status.

Conforms to EC 93/68/EEC,
95/54/EC & VIDG SPEC 5 ISS 7.

Size:- 89mm (L) x 74mm (W) x 31mm (D).

PUMPS & SOLENOIDS



Washer pump.

Available in 12v or 24v.
Universal applications.

Description	Part No.
12v pump	5050010
24v pump	5050011

5050012



Washer pump (24v).

Suitable for ERF, Foden, Leyland
and Seddon/Atkinson.

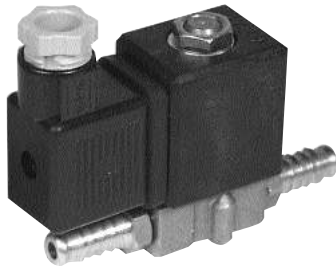

Fuel shut off solenoid.

For use with 8mm internal diameter hose.
Suitable for petrol & diesel applications.
Can be used for anti-theft fuel cut-off with
the use of a concealed switch and **3amp** fuse
(switch & in-line fuse are not included).

Description	Part No.
12v solenoid	9905000
24v solenoid	9905001

8585100



Fuel stop solenoid (12v).

Servicing DPA & DPC pumps.
Nut/stud terminal.
Green insulation.



PUMPS & SOLENOIDS

Engine stop solenoid.

Universal applications.
Pull type operation.



Description	Part No.
12v solenoid	3905008
24v solenoid	3905011

Engine stop solenoid (12v).

Universal applications.
Pull type operation.

[3905009](#)



Engine stop solenoid (24v).

Universal applications.
Pull type operation.

[3905012](#)



Engine stop solenoid (24v).

Universal applications.
Push type operation.

[3905010](#)



PUMPS & SOLENOIDS

[3905007](#)

Engine stop solenoid kit (24v).

Universal applications.
Full kit of parts for complete
installation.
Pull type operation.

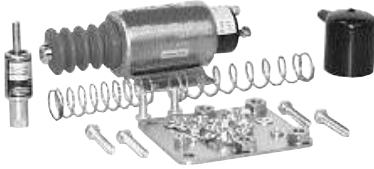



PUMPS & SOLENOIDS

Solenoid.

Available in **12, 24** or **36** volts.
 Insulated.
 Continuously rated.
 Normally open.
 Suitable for various applications,
 pump motors, winch motors
 & starter solenoids etc.



Volts	Continuous	Max*	Part No.
12	80 amp	150 amp	3905000
24	60 amp	100 amp	3905001
36	50 amp	100 amp	3905002

*Maximum amps = per 5 seconds.

Solenoid.

Available in **12, 24** or **36** volts.
 Insulated.
 Continuously rated.
 Changeover contacts (**1 set normally open, 1 set normally closed**).
 Can be used in conjunction with reversible motors.
 Suitable for various applications,
 pump motors & winch motors etc.



Normally Open Ratings			
Volts	Continuous	Max*	Part No.
12	80 amp	150 amp	3905003
24	50 amp	50 amp	3905004

Normally Closed Ratings			
Volts	Continuous	Max*	Part No.
12	60 amp	60 amp	3905003
24	30 amp	30 amp	3905004

*Maximum amps = per 5 seconds.

Solenoid (12v).

Marine applications.
 4 terminal.
 Insulated base.

[3905006](#)



HORNS & GAUGES

HORNS

Disc horn.

2 terminal.
Complete with fixing bracket.

Description	Part No.
12v Low tone	9995000
12v High tone	9995001
24v Low tone	9995002
24v High tone	9995003
36v	9995008
48v	9995009



Trumpet horn.

2 terminal.
Complete with fixing bracket.

Description	Part No.
12v Low tone	9995004
12v High tone	9995005
24v Low tone	9995006
24v High tone	9995007



Twin tone air horn.

Available in 12v or 24v.
Compact space-saving design.
Fast & easy to install with **one** fixing point & **single** electrical connection.
No tubes necessary as it has an incorporated air jet system for instant & perfectly balanced sound.

Description	Part No.
12v	9995061
24v	9995062



Twin tone air horn.

Complete with fixing bracket.
Suitable for emergency vehicles.
Primarily used on motor cycles.

TA/U6A



HORNS

9995030

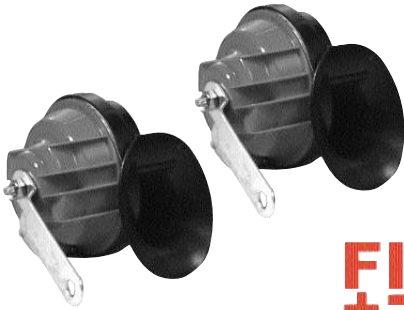

FIAMM
+ —

Electromagnetic horn set.

Designed and constructed for loud and harmonious sound.
1 x high tone, 1 x low tone.
Complete with fixing bracket & relay.
Rated at **12v 10 amps**.
Frequency:- 410 - 510 Hz.

9995037



FIAMM
+ —

Commercial vehicle air horn.

Superior performance on vehicles equipped with on board compressed air.
Compact design allows installation in confined space.
Frequency:- 114db 400Hz.

TF2



FIAMM
+ —

Twin trumpets.

Used in conjunction with **MC/2F1/12V** & **MC/2F1/24V** compressors (see **page 125**).
Suitable for emergency vehicles.

Single blast air horn set.

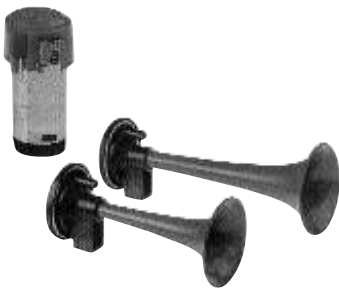

FIAMM
+ —

Available in **12v** or **24v**.
Increased resistance against overheating.
Suitable for heavy duty operating conditions.
External case highly corrosion resistant.
Sealed and waterproof.
Complete with tubing & relay.

Description	Part No.
12v	9995015
24v	9995016

HORNS

Twin trumpets.

Used in conjunction with **MC/2F1/12V & MC/2F1/24V** compressors (see **page 125**). Suitable for emergency vehicles.

[TA/2BL](#)



Twin trumpets.

Used in conjunction with **MC/2F1/12V & MC/2F1/24V** compressors (see **page 125**). Suitable for emergency vehicles.

[TA/2-906V](#)

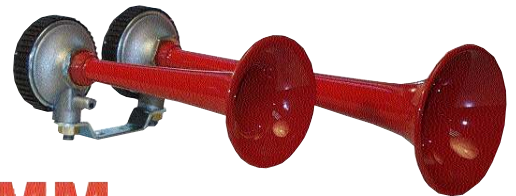

Single blast air horn set (12v).

Provides the design and power as on **9995032 & 9995033** (see **below**), but is suitable for LGV, LCV and 4WD applications. Rated at **20 amps**. Complete with tubing & relay. Length of trumpets:- 320mm. Frequency:- 392 - 415 Hz.

[9995031](#)



Commercial vehicle air horn.

Precision engineered for large vehicles equipped with on board compressed air. Heavy duty.

Description	Part No.
117db 125hz	<u>9995032</u>
Size - 755mm (L) x 170mm (W) x 105mm (D).	
117db 140hz	<u>9995033</u>
Size - 675mm (L) x 170mm (W) x 105mm (D).	



HORNS

Commercial vehicle air horn.

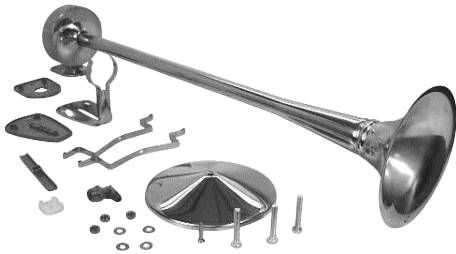

FIAMM
+ —

Precision engineered for large vehicles equipped with on board compressed air. Heavy duty.

Description	Part No.
117db 150hz	9995034
Size - 617mm (L) x 140mm (W) x 140mm (D).	
117db 180hz	9995035
Size - 522mm (L) x 140mm (W) x 140mm (D).	



FIAMM
+ —

Marine air horns.

Combination of heavy chrome plate, brass and stainless steel for protection from salt water. Tuned for extra loud and sharp sound.

Description	Part No.
380hz 1600m range	9995038
Size - 385mm (L) x 95mm (W) x 100mm (D).	
320hz 1600m range	9995039
Size - 430mm (L) x 95mm (W) x 100mm (D).	



FIAMM
+ —

Marine electric horns.

Available in 12v or 24v. Stainless steel cover. Stylish stainless steel pedestal mounting.

Description	Part No.
12v 390hz	9995040
24v 390hz	9995041
Size - 390mm (L) x 95mm (W) x 100mm (D).	
12v 340hz	9995042
Size - 430mm (L) x 95mm (W) x 100mm (D).	

9995046



FIAMM
+ —

Air horn.

Hand held CFC free. Ideal for marine, camping, biking and sports events.

Spares	Description	Part No.
	Refill	9995047



HORNS

Electric valve kit.

Suitable for use with **9995032**, **9995033**,
9995034 & **9995035**
 (see **page 123**),
9995038 & **9995039**
 (see **above**).

Description	Part No.
12v	9995036
24v	9995048

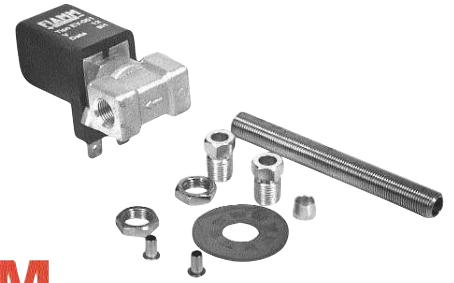

Compressor.

Available in **12v** or **24v**.
12v compressor consumes **20 amps**,
24v consumes **10 amps**.

Description	Part No.
12v	9995044
24v	9995045

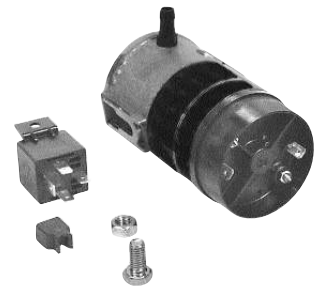

Compressor.

Available in **12v** or **24v**.
 For emergency vehicles only.

Description	Part No.
12V	MC/2F1/12V
24V	MC/2F1/24V

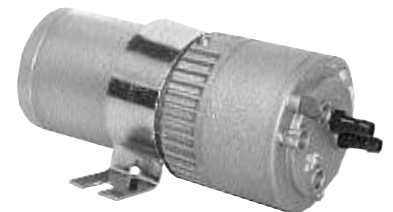

GAUGES

9999000



Ammeter kit.

30-0-30 amps.
Illuminated.
Complete with 12v bulb,
fixing bracket & ring terminals.
52mm Dia.

9999001

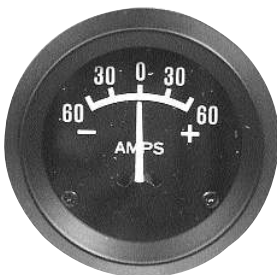

Ammeter kit.

60-0-60 amps.
Illuminated.
Complete with 12v bulb,
fixing bracket & ring terminals.
52mm Dia.

9999002

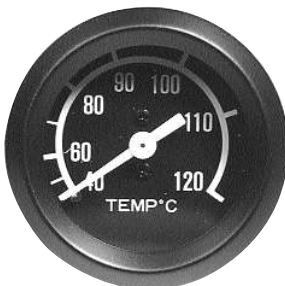

Water temperature gauge kit.

Capillary type.
Illuminated.
Complete with 12v bulb,
fixing bracket & sender unit.
52mm Dia.

9999007



Water temperature gauge kit (12v).

Electric.
Illuminated.
Complete with 12v bulb,
fixing bracket, terminal
block & sender unit.
52mm Dia.

GAUGES

Water temperature gauge kit (24v).

[9999008](#)

Electric.
Illuminated.
Complete with 24v bulb,
fixing bracket, terminal
block and sender unit.
52mm Dia.



Voltmeter kit (12v).

[9999003](#)

Illuminated.
Complete with 12v bulb,
fixing bracket and
terminal block.
52mm Dia.



Voltmeter kit (24v).

[9999004](#)

Illuminated.
Complete with 24v bulb,
fixing bracket and
terminal block.
52mm Dia.



Oil pressure gauge kit (12v).

[9999005](#)

Electric.
Illuminated.
Complete with 12v bulb,
fixing bracket, terminal
block and sender unit.
52mm Dia.



GAUGES

9999006



Oil pressure gauge kit (24v).

Electric.
Illuminated.
Complete with 24v bulb, fixing bracket, terminal block and sender unit.
52mm Dia.

9999012



Oil pressure gauge kit.

Capillary type.
Illuminated.
Complete with 12v bulb and fixing bracket.
52mm Dia.

9999011



Hour counter kit (8-32v).

Non illuminated.
Complete with fixing bracket and lucar terminals.
52mm Dia.

9999013



Digital hour counter kit (12-48v).

L.E.D illumination.
Complete with fixing bracket and lucar terminals.
56mm Dia.



REVERSING AIDS

REVERSING CAMERA SYSTEMS

TFT Colour Reversing Kit

Kit includes : 1x Camera, 1x 5.6" colour monitor, 0.25" image sensor, 20m cable, control box & fitting kit.

Camera : Colour CCD camera.

Monitor : 5.6" TFT LCD colour monitor.



Description	Part No.
Kit - All Parts Included	9995073
Camera	9995274
20m Cable	9995275
Monitor	9995276
Control Box	9995277

[9995278](#)

TFT Colour Reversing Kit

Kit includes : 1x Camera, 1x 5.6" colour monitor, 0.25" image sensor, 20m cable, control box & fitting kit.

Camera : 1 Watt power consumption. Water/dust resistant. 30mm (L) x 228mm (W) x 33mm (H).

Monitor : 3.5" TFT LCD colour monitor. Weighs 146g and used 5 Watts. Embedded camera also available.

Operates between -10°C and +50°C. Ideal for cars and small vans. 100mm (L) x 24mm (W) x 80mm (H).





REVERSING CAMERA SYSTEMS

TFT Colour Reversing Kit

Kit includes : Choice of 1x or 2x Camera, 1x 5.6" colour monitor, 0.33" CCD image sensor, 20m cable, universal stand and remote control.

Camera : Integral microphone. 18 inferred LED's for night viewing. Utilises mirror image. Waterproof. 60mm (L) x 64mm (W) x 69mm (H).

Monitor : High quality (A) class 5" TFT LCD colour monitor. 960 x 240 resolution. 3 Video inputs. Auto switching for reverse. Built in speakers. 4 Viewing options. 163mm (L) x 130mm (W) x 30mm (H).

Operates between -20°C and +60°C.



Description	Part No.
Kit - 1x Camera, Monitor + Accessories	9995280
Spare Camera + Cable & lead	9995281
Kit - 2x Camera, Monitor + Accessories	9995282

TFT Colour Reversing Kit

[9995287](#)

High quality reversing camera system.

Kit includes : 1x Camera, 1x 5" colour monitor, 20m cable, universal stand and remote control.

Camera : Sharp CCD camera with 15 inferred LED's for night viewing. Built in audio for added safety. Support for optional second camera. Waterproof/dustproof grade IP68. Lens angle 110°. 315g weight. Mirror/normal image can be set using a switch on the rear of the camera. 87mm (L) x 70mm (W) x 59.5mm (D)

Monitor : 5" TFT LCD colour monitor. Built in controller with 2 camera inputs. Day/night sensor for automatic adjustment. 12/24v DC, <7W. 535g (Including stand). 147mm (L) x 110mm (W) x 59mm (D)



REVERSING ALARMS / AIDS**9995057****Reversing alarm (12v/24v).**

Heavy duty.
Suitable for cars, coaches,
buses, H.G.V. & plant etc.
Sound level dB(A):- **97**.

9995058**Reversing alarm (12v/24v).**

Heavy duty.
Night silent feature cuts
out the alarm when the
vehicles lights are on.
Suitable for cars, coaches,
buses, H.G.V. & plant etc.
Sound level dB(A): - **97**.

9995059**Reversing alarm (12v/24v).**

Heavy duty.
Night silent feature cuts
out the alarm when the
vehicles lights are on
with override option
for additional safety.
Suitable for cars, coaches,
buses, H.G.V. & plant etc.
Sound level dB(A):- **97**.

9995060**Talking Reversing alarm
(12v/24v).**

Heavy duty.
Night silent feature cuts
out the alarm when the
vehicles lights are on
with override option
for additional safety.
Suitable for cars, coaches,
buses, H.G.V. & plant etc.
Sound level dB(A):- **97**.



REVERSING ALARMS / AIDS

Reversing alarm (12-80v).

Suitable for trucks, buses, coaches, light mobile plant and industrial vehicles.
Screw terminals.
Sound level dB(A):- 97.

[9995025](#)



Reversing alarm (12/24v).

Light duty.
Suitable for most light vehicles and small forklift trucks.
Sound level dB(A):- 90.

[9995063](#)



Reversing alarm (12/24v).

Light duty.
Optional night silent feature cuts out the alarm when the vehicles lights are on.
Suitable for most light vehicles and small forklift trucks.
Sound level dB(A):- 90.

[9995017](#)



Reversing alarm.

Broadband sound technology (bbs-tek).
Heavy duty.
Suitable for construction plant and earth moving equipment.

Description	Part No.
Output dB(A) @ 1mtr 108.6 (24v)	9995049
Output dB(A) @ 1mtr 103.6 (24v)	9995050



REVERSING ALARMS / AIDS

Reversing alarm.



Broadband sound technology (bbs-tek).
Medium duty.
Suitable for construction vehicles
and light mobile machinery.

Description	Part No.
Output dB(A) @ 1mtr 93.6 (12v & 24v)	9995051
Output dB(A) @ 1mtr 98.6 (12v & 24v)	9995054

Reversing alarm.



Broadband sound technology (bbs-tek).
Light duty.
Suitable for light commercial
vehicles and fork lift trucks.

Description	Part No.
Output dB(A) @ 1mtr 88.6 (12v & 24v)	9995052
Output dB(A) @ 1mtr 93.6 (12v & 24v)	9995053

[9995029](#)



Reversing alarm (12v/24v).

Nightshift technology (double engage reverse
and the reverse alarm will not sound).
Suitable for commercial vehicles and buses etc.
Sound level dB(A):- **90**.

[9995023](#)



Reversing alarm (24v).

Light duty.
Suitable for light vehicles
and small forklift trucks.
Sound level dB(A):- **90**.



REVERSING ALARMS / AIDS

Reversing alarm (12/24v).

[9995022](#)

Light duty.
Suitable for trucks, buses, coaches,
light mobile plant and industrial vehicles.
Sound level dB(A):- 97.



Self adjusting reversing alarm (12/24v).

[9995024](#)

Heavy duty.
Alarm automatically adjusts to 5-10db
louder than surrounding noise levels.
Suitable for dump trucks, bulldozers,
loading shovels and all heavy earth
moving machinery.
Sound level dB(A):- 87-112.



Reversing alarm (12-36v).

[9995021](#)

Heavy duty.
Suitable for dump trucks, bulldozers,
loading shovels and all heavy
earth moving machinery.
Sound level dB(A):- 112.

NO LONGER AVAILIABLE



Reversing alarm (12-36v).

[9995019](#)

Medium duty.
Suitable for trucks, buses, coaches,
light mobile plant and industrial vehicles.
Sound level dB(A):- 90.

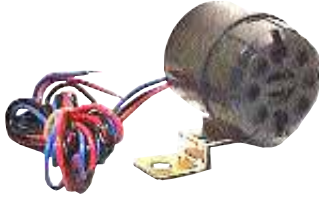

REVERSING ALARMS / AIDS**9995020****BRIGADE®*****Reversing alarm (12/24v).***

Light duty.

Optional night silent feature cuts out the alarm when the vehicles lights are on.

Suitable for most light vehicles and small forklift trucks.

Sound level dB(A):- 90.

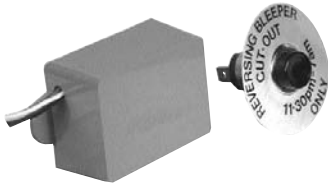
9995027**BRIGADE®*****Backalarm cut-out (12/24v).***

Dash-mounted single-touch timed relay.

Allows driver to temporarily cut off the reverse alarm.

Auto resets after 3-4 mins.

9995028**BRIGADE®*****Wide-View reversing lens.***

Allows wide angle viewing to normally 'blind' areas.

Self adhesive.

Rigid PVC fresnel lens.

Size:- 200mm x 254mm.



MISCELLANEOUS

MISCELLANEOUS

Tidgy Fridge (12v).

Complete with 2mtr cord and cigarette lighter plug.
Auto shut-off to prevent overheating.

7ltr capacity.

Size:- 250mm (H) x 142mm (W) x 140mm (D).

8151013*



*Deluxe version also available with mains adaptor, please ask for details.

Travel cooler (12v).

Complete with 2mtr cord and cigarette lighter plug.
Auto shut-off to prevent overheating.

6ltr capacity.

Size:- 200mm (H) x 130mm (W) x 200mm (D).

8151014



Handiwash.

Hot & cold water.

Water capacity - **8.5ltrs.**

Size:- 300mm (W) x 520mm (H) x 230mm (D).

Depth with tray open:- 405mm.



	Description	Part No.
	12v Handiwash	8151002
	24v Handiwash	8151003
Spares	12v Electrical fitting kit*	8151004*
	24v Electrical fitting kit*	8151005*

*Note: The relevant fitting kits **MUST** be used when installing these Handiwashes in **ALL** 12v and 24v applications

Miniwash.

Hot water only.

Water capacity - **6ltrs.**

Size:- 300mm (W) x 390mm (H) x 222mm (D).

Depth with tray open:- 400mm.



	Description	Part No.
	12v Miniwash	8151018
	24v Miniwash	8151019
Spares	12v Electrical fitting kit*	8151004*
	24v Electrical fitting kit*	8151005*

*Note: The relevant fitting kits **MUST** be used when installing these Handiwashes in **ALL** 12v and 24v applications

MISCELLANEOUS



Oscillating fans.

Available in 12v or 24v.
6" diameter.

Description	Part No.
12v Fan	9999020
24v Fan	9999021

9980001



Bosch free wheel pulley removal tool.

Necessary for carrying out the removal and re-fitting of pulleys to the new generation of internally fanned Bosch alternators.
Designed for use on pulleys with 28mm hexagonal inserts or splines.
Manufactured from hardened steel.

8151015



Light delay

Holds interior lights on for approx. 15 seconds at 80% brightness.

***Important Note:** An old unit is required as this is a **Service Exchange** item. Veeder Root units are not accepted.

MISCELLANEOUS

Height indicator.

Plastic construction.
For internal use.
Displays height in feet & inches
(numbers included).
2 or 4 hole fixing.
Can be used with **LH24** (see **page 174**).
Size:- 180mm (W) x 187mm (217mm inc top bracket) (H) x 7mm (D).

PLH60



VTG6A MOT holder.

Plastic construction.
Complete with clear plastic
sleeve for external use.
2 or 4 hole fixing.
Can be used with **LH24** (see **page 174**).
Size:- 180mm (W) x 187mm (217mm inc top bracket) (H) x 7mm (D).

PLH52



MISCELLANEOUS**645/01/00****License plate holder.**

Plastic construction.
Will accept plastic plates 280mm (L) x 202mm (H).
Size:- 328mm (L) x 258mm (H) x 28mm (D).

LH24**Tax disc holder.**

Metal construction.
Splash proof.
3 hole fixing.
Can be attached to
PLH52 & PLH60
height indicator/MOT holder
(see **page 173**).

ALH188/50**Tax disc holder.**

Self adhesive.

BMAC440**Triple tax disc holder.**

Metal construction with
graphite grey finish.
Hinge mounted.
2 hole fixing.



MISCELLANEOUS

Latex gloves.

Powdered.
Box of 100.



Description	Part No.
Medium	8151016
Large	8151001

Floor mats.

Crepe paper.
Protects the footwell area
from soiling in wet, greasy
or oily conditions.
Box of 100.

[GOC0071](#)



Disposable seat covers.

Top feed.
Protects seats from soiling in wet,
greasy or oily conditions.
Generous fitting to accommodate
large vehicles.
Roll of 100.

[GOC0064](#)



Disposable seat covers.

Centre fed.
Protects seats from soiling in wet,
greasy or oily conditions.
Generous fitting to accommodate
large vehicles.
Box of 100.

[GOC0995](#)



MISCELLANEOUS

RTV310 silicon sealant.



Resistant to temperatures from **-60°C to +250°C**.
Will not crack, harden or dry out.
Available in various colours.
Contents:- **310ml**.

Description	Part No.
Clear	GOC0235
Black	GOC0236
White	GOC0240

[GOC0456](#)



Red instant gasket.

Withstands intermittent high temperatures up to **650°F (343°C)**.
Ideal when replacing gaskets on valve covers, transmission & oil sumps, axle covers, exhaust manifolds plus many more applications.
Resists transmission fluids, water, oil & antifreeze.
Contents:- **200ml**.

[9994047](#)



Battery Hold down clamp.

Punched angled bracket 348mm (L).
2 threaded J bolts 385mm (L) with wing nuts.
Adjusts to fit most popular sizes of battery.

Wheel checkpoint indicators.



Yellow.
Various sizes.

Size	Part No.
24mm	8151006
27mm	8151007
28mm	8151008

Size	Part No.
30mm	8151009
32mm	8151010
33mm	8151011



MISCELLANEOUS

Junior hacksaw blades.

General purpose blades with pinned ends.
Will fit all junior hacksaw frames.

Supplied in packs of 10.

[57431](#)



Hacksaw blades.

Bi-metal blades.
Unique variable pitch profile teeth for superior performance on a wide range of materials.

Standard pitch 20-24tpi.

Supplied in packs of 10.

[HSB/10](#)



PTFE tape.

For water plumbing applications (not suitable for use on gas pipework).

Size:- 12mtrs x 12mm.

Supplied per roll.

[63389](#)



Masking tape.

Length:- 50mtrs per roll.

Supplied per roll.

Description	Part No.
25mm (1") tape	<u>MT25/9</u>
50mm (2") tape	<u>MT50C/24</u>

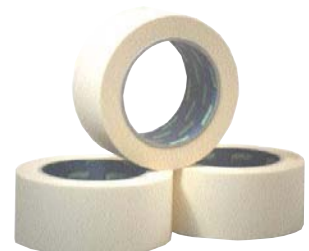

MISCELLANEOUS

AK44



Side lever grease gun.

Die cast pump head with air bleed valve.
Supplied with rigid extension tube
& push on hydraulic 4 jaw coupling.
Bulk or manual capability.
3 way fill with cartridge.
Accepts standard 400g cartridges.

TP05



Oil can.

Flexible spout.
Thumb operated lever action.
500ml capacity.

TPJ005



Flexi-jug.

Heavy duty plastic construction.
6.6ltr capacity.
(Not suitable for storing
or transporting petrol).

TFF001



Flexi-funnel.

Plastic construction.
Short fixed spout for stability.
Flexible spout for difficult to
reach areas.
Removeable filter mesh
for cleaning.
Splash guard rim.
Large 144mm opening for
ease of pouring.



MISCELLANEOUS

Squeegee.

Suitable for cleaning windows/glass.
Complete with coarse and soft
sponge and squeegee for removing
excess water.

[SCR003](#)



Assorted steel washer kit.

Metric.
Approx 840 pieces.

[9071415](#)

Contents
M5
M6
M8

Contents
M10
M12
M16



Assorted heavy duty washer kit.

Metric.
Approx 605 pieces.

[9071441](#)

Contents
M3
M4
M5
M6
M8

Contents
M10
M12
M16
M20



Assorted copper washer kit.

Imperial.
Approx 800 pieces.

[9071439](#)

Contents
1/4" x 3/8" x 20G
1/4" x 7/16" x 20G
1/4" x 1/2" x 20G
5/16" x 7/16" x 20G
5/16" x 1/2" x 20G
3/8" x 1/2" x 18G

Contents
1/2" x 11/16" x 20G
1/2" x 3/4" x 18G
5/8" x 7/8" x 18G
13/16" x 1" x 18G
15/16" x 1-1/8" x 16G



MISCELLANEOUS

9071440



Assorted fibre washer kit.

Imperial.
Approx 840 pieces.

Contents
13/64" x 3/8"
1/4" x 3/8"
5/16" x 5/8"
21/64" x 1/2"
3/8" x 5/8"
3/8" x 7/8"

Contents
29/64" x 11/16"
1/2" x 11/16"
17/32" x 3/4"
37/64" x 7/8"
5/8" x 7/8"
49/64" x 1"

9071414



Assorted spring washer kit.

Metric.
Approx 880 pieces.

Contents
M5
M6
M8

Contents
M10
M12

9071434



Assorted M6 fastener, nut & washer kit.

Metric.
Approx 405 pieces.

Contents
M6 x 16 screw
M6 x 20 screw
M6 x 25 screw
M6 x 35 screw

Contents
M6 x 50 screw
M6 steel nuts
M6 steel washers

9071433



Assorted M8 fastener, nut & washer kit.

Metric.
Approx 290 pieces.

Contents
M8 x 20 screw
M8 x 25 screw
M8 x 40 screw
M8 x 50 screw

Contents
M8 x 80 screw
M8 steel nuts
M8 steel washers



MISCELLANEOUS

Assorted M10 fastener, nut & washer kit.

[9071432](#)

Metric.
Approx 290 pieces.

Contents
M10 x 25 screw
M10 x 40 screw
M10 x 50 screw

Contents
M10 x 75 screw
M10 steel nuts
M10 steel washer



Assorted self tapping pan head screw kit.

[9071425](#)

Approx 700 pieces.

Contents
No4 x 1/2"
No6 x 1/2"
No6 x 3/4"
No8 x 1/2"
No8 x 3/4"
No8 x 1"

Contents
No10 x 1/2"
No10 x 3/4"
No10 x 1"
No12 x 3/4"
No12 x 1"



Assorted self tapping black pan head screw kit.

[9071426](#)

Approx 700 pieces.

Contents
No4 x 1/2"
No6 x 1/2"
No6 x 3/4"
No8 x 1/2"
No8 x 3/4"
No8 x 1"

Contents
No10 x 1/2"
No10 x 3/4"
No10 x 1"
No12 x 3/4"
No12 x 1"

Assorted black (flanged) self tapping screw kit.

[9071427](#)

Approx 700 pieces.

Contents
No6 x 1/2"
No6 x 3/4"
No8 x 1/2"
No8 x 3/4"

Contents
No8 x 1-1/2"
No10 x 1/2"
No10 x 3/4"

MISCELLANEOUS

9071436



Assorted screw & fastener kit.

Approx 400 pieces.

Contents
No8 x 19mm screw
No10 x 19mm screw
No12 x 19mm screw
No14 x 19mm screw

Contents
No8 J clip
No10 J clip
No12 J clip
No14 J clip

9071424



Assorted "E" retaining ring kit.

Approx 1500 pieces.

Contents
3/32"
1/8"
5/32"
3/16"

Contents
7/32"
1/4"
5/16"
3/8"

9071430



Assorted star lock push on fastener kit.

Approx 1050 pieces.

Contents
2.5mm
3mm
3.5mm
4mm
4.5mm
5mm

Contents
5.5mm
6mm
6.5mm
7mm
8mm
9mm

9071442



Assorted split pin kit.

Small sizes.
Approx 950 pieces.

Contents
1/16" X 1"
1/8" X 1-1/2"
5/64" X 1"
3/32" X 1"

Contents
7/64" X 1-1/2"
9/64" X 1-1/2"
5/32" X 3/4"



MISCELLANEOUS

Assorted split pin kit.

Large sizes.
Approx 200 pieces.

[9071443](#)

Contents
1/8" x 1-1/2"
5/32" x 2"
3/16" x 2"
1/4" x 3"
5/16" x 3"



Assorted aluminium pop rivet kit.

Approx 575 pieces.

[9071444](#)

Contents
1/8" x 1/2" x 1/32" washer
1/8" x 5/16" rivet
1/8" x 1/2" rivet
5/32" x 1/2" rivet

Contents
3/16" x 1/2" rivet
3/16" x 3/4" rivet
3/16" x 1/2" rivet
3/16" x 1" rivet



Assorted grommet kit.

Approx 100 pieces.

[9071417](#)

Contents
6.4mm x 14.3mm
6.4mm x 25.4mm
7.9mm x 15.9mm
9.5mm x 19.1mm

Contents
12.7mm x 34.9mm
19.1mm x 41.3mm
25.4mm x 47.6mm



Assorted wiring & blanking grommet kit.

Approx 160 pieces.

[9071445](#)

Contents
4mm x 6.4mm (W)
5.5mm x 8mm (W)
6.4mm x 9.5mm (W)
8mm x 9.5mm (W)
9.5mm x 12.5mm (W)
11mm x 12.5mm (W)
12.5mm x 17.5mm (W)

Contents
14.2mm x 17.5mm (W)
16mm x 19mm (W)
6.4mm x 9.5mm (B)
8mm x 14.2mm (B)
9.5mm x 15.4mm (B)
11.2mm x 17.7mm (B)
12.5mm x 18.7mm (B)

Contents
15.5mm x 22mm (B)
19mm x 25.5mm (B)
20mm x 25.5mm (B)
22mm x 28.4mm (B)

(W) = wiring,
(B) = blanking.



MISCELLANEOUS

9071431



Contents

Contents

9998044



Single pole plug.

Plastic body.
2 screw terminals.
Straight cable entry.
Rated to ISO 4165,
DIN 72591.
For use with **9998025**
& **9998045**
(see **below**).

9998025

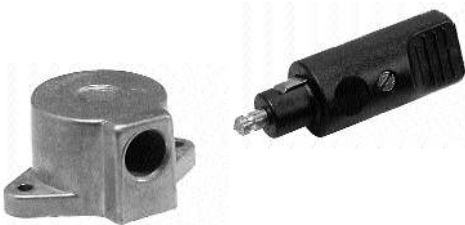

Plug & socket assembly.

Single pin plastic plug
(as **9998044** above).
Aluminium socket for
external mounting.

9998045



Single pole socket.

Nickel plated brass body.
2 screw terminals.
Complete with spring loaded cover.
Rated to ISO 4165,
DIN 72591.
For use with **9998043**
(see **page 86**) & **9998044**
(see **above**).



MISCELLANEOUS

Economy wiper blades.

Sizes:- 11" - 24" available.

Part No
TW11
TW13
TW14
TW15
TW16
TW17

Part No.
TW18
TW19
TW20
TW21
TW22
TW24



Bosch wiper blades.

Internal tension strip keeps constant pressure across the blade as the screen curves.

High quality rubber spine enables effective flipover functions.

Precision cut cleaning edge ensures smear free wiping.

Pre-mounted quick-clip adapters makes fitting the blade a quick & simple process.

Sizes:- 11" - 26" available.



Part No
SP11
SP13
SP15
SP16
SP17
SP18
SP19

Part No.
SP20
SP21
SP22
SP23
SP24
SP26

N.B. - Spoiler blades & blade kits also available, please ask for more details.

PART NUMBER INDEX

Part no.	Page	Part no.	Page	Part no.	Page
108/01/00	37	9070012	22	9071003.05	38
111/01/00	36	9070013	22	9071003.07	38
111/01/01	36	9070014	22	9071003.10	38
111/01/02	36	9070015	22	9071003.15	38
111/07/00	36	9070016	22	9071003.20	38
111/07/01	37	9070017	22	9071003.25	38
120/07/02	37	9070018	22	9071003.30	38
201.100	14	9070019	22	9071004.10	38
201.308	15	9070020	22	9071004.100	38
201.413	17	9070021	22	9071004.20	38
201.545	16	9070022	22	9071004.30	38
201.772	18	9070023	22	9071004.40	38
35670	7	9070024	22	9071004.50	38
3905000	77	9070025	22	9071004.60	38
3905001	77	9070026	22	9071004.70	38
3905002	77	9070027	22	9071004.80	38
3905003	77	9070028	22	9071005.30	38
3905003	77	9070029	22	9071005.40	38
3905004	77	9070030	22	9071005.60	38
3905004	77	9070031	22	9071005.80	38
3905006	77	9070035	23	9071006.30	39
3905007	76	9070036	23	9071006.40	39
3905008	75	9070037	23	9071006.60	39
3905009	75	9070038	23	9071006.80	39
3905010	75	9070039	23	9071007.100	39
3905011	75	9070040	23	9071007.30	39
3905012	75	9070041	23	9071007.40	39
5050010	74	9070042	23	9071007.60	39
5050011	74	9070043	23	9071007.80	39
5050012	74	9070044	23	9071008.03	40
57431	103	9070045	23	9071008.05	40
63389	103	9070046	23	9071008.13	40
645/01/00	100	9070047	23	9071009.05	40
8151001	101	9070048	23	9071009.08	40
8151002	97	9070049	23	9071009.16	40
8151003	97	9070050	23	9071009.25	40
8151004*	97	9070051	23	9071010.30	40
8151004*	97	9070052	23	9071010.40	40
8151005*	97	9070052	23	9071010.50	40
8151005*	97	9070053	23	9071010.60	40
8151006	102	9070054	23	9071010.80	40
8151007	102	9071000.03	38	9071011.06	42
8151008	102	9071000.04	38	9071011.08	42
8151009	102	9071000.05	38	9071011.10	42
8151010	102	9071000.10	38	9071011.15	42
8151011	102	9071000.15	38	9071011.20	42
8151013*	97	9071000.20	38	9071011.25	42
8151014	97	9071000.25	38	9071012.06	42
8151015	98	9071000.30	38	9071012.08	42
8151016	101	9071001.02	39	9071012.10	42
8151018	97	9071001.03	39	9071012.15	42
8151019	97	9071001.05	39	9071012.20	42
8585100	74	9071002.01	39	9071012.25	42
9070000	21	9071002.02	39	9071013.05	42
9070000	21	9071002.03	39	9071013.07	42
9070001	21	9071002.05	39	9071013.10	42
9070001	21	9071002.07	39	9071013.15	42
9070002	21	9071002.10	39	9071013.20	42
9070003	21	9071002.15	39	9071013.25	42
9070004	21	9071002.20	39	9071014.05	42
9070005	21	9071002.25	39	9071014.07	42
9070006	21	9071002.35	39	9071014.10	42
9070007	22	9071002.50	39	9071014.15	42
9070008	22	9071003.01	38	9071014.20	42
9070009	22	9071003.02	38	9071014.25	42
9070010	22	9071003.03	38	9071015.05	43
9070011	22	9071003.04	38	9071015.10	43



PART NUMBER INDEX

Part no.	Page	Part no.	Page	Part no.	Page
9071015.15	43	9071309	30	9089029	31
9071015.20	43	9071310	30	9089030	31
9071015.30	43	9071311	30	9089031	31
9071050	30	9071312	30	9090000	33
9071051	30	9071313	30	9090001	33
9071053	30	9071401	29	9090002	33
9071060	43	9071402	29	9090003	33
9071061	44	9071410	41	9090004	33
9071062	44	9071411	41	9090005	33
9071063	44	9071412	41	9090006	33
9071064	44	9071413	28	9090007	33
9071065	43	9071414	106	9090008	33
9071066	45	9071415	105	9091000	35
9071100	30	9071416	27	9091001	35
9071101	30	9071417	109	9091002	35
9071102	30	9071418	28	9091003	35
9071103	30	9071419	27	9091004	33
9071104	30	9071420	28	9091005	33
9071105	30	9071421	28	9091006	33
9071106	30	9071422	26	9091007	33
9071107	30	9071423	27	9091008	34
9071108	30	9071424	108	9091009	34
9071109	30	9071425	107	9091010	34
9071110	30	9071426	107	9091011	34
9071111	30	9071427	107	9091012	34
9071112	30	9071428	40	9091013	34
9071113	30	9071429	41	9091014	34
9071114	30	9071430	108	9091015	34
9071115	30	9071431	110	9091016	34
9071116	30	9071432	107	9091017	35
9071117	30	9071433	106	9091018	35
9071118	30	9071434	106	9091019	34
9071119	30	9071435	26	9091020	34
9071200	30	9071436	108	9881014	72
9071201	30	9071437	26	9881023	72
9071202	30	9071438	27	9881024	72
9071203	30	9071439	105	9881025	72
9071204	30	9071440	106	9905000	74
9071205	30	9071441	105	9905001	74
9071206	30	9071442	108	9980001	98
9071207	30	9071443	109	9980002	37
9071208	30	9071444	109	9987007	63
9071209	30	9071445	109	9994000	32
9071210	30	9089000	31	9994001	32
9071211	30	9089001	31	9994002	32
9071212**	30	9089002	31	9994003	32
9071213	30	9089003	31	9994004	32
9071214	30	9089004	31	9994005	32
9071215	30	9089005	31	9994006	32
9071216**	30	9089006	31	9994007	32
9071217	30	9089012	31	9994008	32
9071219	30	9089013	31	9994009	32
9071220	30	9089014	31	9994010	32
9071221	30	9089015	31	9994011	32
9071222	30	9089016	31	9994020	32
9071223	30	9089017	31	9994021	32
9071224	30	9089018	31	9994022	32
9071225	30	9089019	31	9994023	32
9071226	30	9089020	31	9994024	32
9071300	30	9089021	31	9994025	32
9071301	30	9089022	31	9994026	32
9071302	30	9089023	31	9994030	25
9071303	30	9089024	31	9994031	25
9071304	30	9089025	31	9994032	25
9071306	30	9089026	31	9994033	25
9071307	30	9089027	31	9994034	26
9071308	30	9089028	31	9994035	26

PART NUMBER INDEX

Part no.	Page	Part no.	Page	Part no.	Page
9994036	25	9995275	88	9997005	70
9994037	25	9995276	88	9997007	70
9994038	25	9995277	88	9997008	71
9994039	25	9995278	88	9997009	71
9994040	24	9995280	89	9997010	71
9994041	24	9995281	89	9997011	71
9994042	24	9995282	89	9997012	70
9994043	24	9995287	89	9997050	45
9994044	24	9996000	5	9997051	46
9994045	24	9996000K	5	9997052	46
9994046	24	9996001	6	9997053	46
9994047	102	9996002	7	9997054	45
9995000	79	9996013	7	9997055	45
9995001	79	9996015	43	9997056	48
9995002	79	9996015	10	9997057	46
9995003	79	9996017	10	9997058	47
9995004	79	9996018	10	9997059	47
9995005	79	9996022	10	9997060	47
9995006	79	9996025	11	9997061	47
9995007	79	9996026	13	9998001	57
9995008	79	9996027	13	9998002	58
9995009	79	9996030	5	9998003	51
9995015	80	9996030K	5	9998004	51
9995016	80	9996031	6	9998005	52
9995017	91	9996032	6	9998006	52
9995019	93	9996033	7	9998007	55
9995020	94	9996034	7	9998008	56
9995021	93	9996035	8	9998009	52
9995022	93	9996036	8	9998009	52
9995023	92	9996037	8	9998009	53
9995024	93	9996038	8	9998009	52
9995025	91	9996039	8	9998010	51
9995027	94	9996040	8	9998011	57
9995028	94	9996041	8	9998012	59
9995029	92	9996042	9	9998013	59
9995030	80	9996043	9	9998014	63
9995031	81	9996044	9	9998015	63
9995032	81	9996045	9	9998016	58
9995033	81	9996046	9	9998017	54
9995034	82	9996047	9	9998018	59
9995035	82	9996048	9	9998019	52
9995036	83	9996049	10	9998020	63
9995037	80	9996050	12	9998021	60
9995038	82	9996051	12	9998022	60
9995039	82	9996052	11	9998023	60
9995040	82	9996053	11	9998024	60
9995041	82	9996054	12	9998025	110
9995042	82	9996055	11	9998026	51
9995044	83	9996057	6	9998027	57
9995045	83	9996057K	7	9998028	54
9995047	82	9996057K	6	9998029	55
9995048	83	9996500	19	9998030	53
9995049	91	9996501	19	9998031	55
9995050	91	9996502	19	9998032	54
9995051	92	9996503	19	9998033	56
9995052	92	9996504	19	9998034	52
9995053	92	9996505	19	9998035	53
9995054	92	9996506	19	9998036	56
9995057	90	9996507	19	9998037	53
9995058	90	9996508	19	9998038	56
9995059	90	9996509	19	9998039	53
9995060	90	9996510	19	9998040	57
9995061	79	9997000	69	9998041	58
9995062	79	9997001	69	9998042	61
9995063	91	9997002	69	9998043	65
9995073	88	9997003	69	9998044	110
9995274	88	9997004	70	9998045	110



PART NUMBER INDEX

Part no.	Page	Part no.	Page
9998046	58	SP15	111
9998047	54	SP16	111
9998048	62	SP17	111
9998050	61	SP18	111
9998052	61	SP19	111
9998054	62	SP20	111
9998055	61	SP21	111
9998056	62	SP22	111
9998057	62	SP23	111
9998058	59	SP24	111
9998059	55	SP26	111
9998060	65	TA/2-906V	81
9998061	65	TA/2BL	81
9998062	66	TA/U6A	79
9998063	66	TF2	80
9998064	66	TFF001	104
9998065	64	TP05	104
9998066	64	TPJ005	104
9998067	64	TW11	111
9998068	64	TW13	111
9998069	65	TW14	111
9999000	84	TW15	111
9999001	84	TW16	111
9999002	84	TW17	111
9999003	85	TW18	111
9999004	85	TW19	111
9999005	85	TW20	111
9999006	86	TW21	111
9999007	84	TW22	111
9999008	85	TW24	111
9999011	86		
9999012	86		
9999013	86		
9999020	98		
9999021	98		
AK44	104		
ALH188/50	100		
BMAC440	100		
BSPSSC12	24		
BSPSSC24	24		
GOC0064	101		
GOC0071	101		
GOC0235	102		
GOC0236	102		
GOC0240	102		
GOC0456	102		
GOC0995	101		
HSB/10	103		
LH24	100		
MC/2F1/12V	83		
MC/2F1/24V	83		
MT25/9	103		
MT50C/24	103		
Part number: 9070060	23		
Part number: 9070061	23		
Part number: 9070061	23		
Part number: 9070062	23		
Part number: 9070063	23		
Part number: 9070064	23		
Part number: 9070065	23		
Part number: 9070066	23		
Part number: 9070067	23		
PLH52	99		
PLH60	99		
SCR003	105		
SP11	111		
SP13	111		

